

# High speed door

## ASSA ABLOY HS9020GAT

**ASSA ABLOY**  
Entrance Systems

Experience a safer  
and more open world



### Airtight high speed door for cleanroom applications

The ASSA ABLOY HS9020GAT is airtight and designed for cleanrooms and other areas with a controlled or filtered atmosphere. The main features of the ASSA ABLOY HS9020GAT are:

- Medium-sized, max. 4000 x 4000 mm
- Airtight/Cleanroom applications
- Inside usage
- Galvanised steel construction, option Stainless steel 304
- Gravity drive system
- Opening speed up to 1,2 m/s (Option: 2,0 m/s)

The ASSA ABLOY HS9020GAT offers a perfect sealing thanks to a unique continuous side seal along the curtain. It requires very little space and protects areas against drafts, humidity, and contamination.

Exceptional reliability and smooth operation is ensured by a frequency controlled motor which provides a fast but soft start and stop.

The reliable and versatile control unit ensures precise door set up and diagnostics and is enclosed in a robust steel control box. A customer friendly clear display gives a wide range of information like an easy to read cycle counter.

#### Break-away and Automatic Reset system

ASSA ABLOY high speed doors are equipped with a break-away and automatic reset system. The curtain reintroduces itself after a crash to reduce downtime and maintenance.

#### Completely safe

Features that make our doors completely safe.

- The soft bottom profile has no rigid parts, it gives way should an obstruction be in the line of closing.
- If the door is hit, the fabric curtain absorbs the impact and releases itself from its side guides without causing damage or being damaged itself.

#### Windows and vision panels

To increase the admission of daylight and visibility, the door curtain can be equipped with windows or vision panels. Windows have fixed sizes and are located on a pre-defined grid. A vision panel is always located on the full width of the door curtain.

### Technical Data

Min size (W x H)	1000 x 2000 mm
Max size (W x H) <sup>1</sup>	4000 x 4000 mm
Operating speed <sup>2</sup>	opening: up to 2,0 m/s closing: 0,5 m/s
Wind load resistance, EN 12424	class 1 (300 N/m <sup>2</sup> ) maximum wind load while closing 50 N/m <sup>2</sup>
Water penetration, EN 12425	class 2 (50 N/m <sup>2</sup> )
Air permeability, EN 12426	class 3, overpressure <sup>3</sup> class 1, underpressure
Thermal transmittance	6,02 W/(m <sup>2</sup> K)
Performance Test	1.000.000 cycles

1) Other sizes available on request 2) Depending on door size 3)  $\leq 3500 \times 3500$ , installed on the outside of the cleanroom

## Dimensional specifications

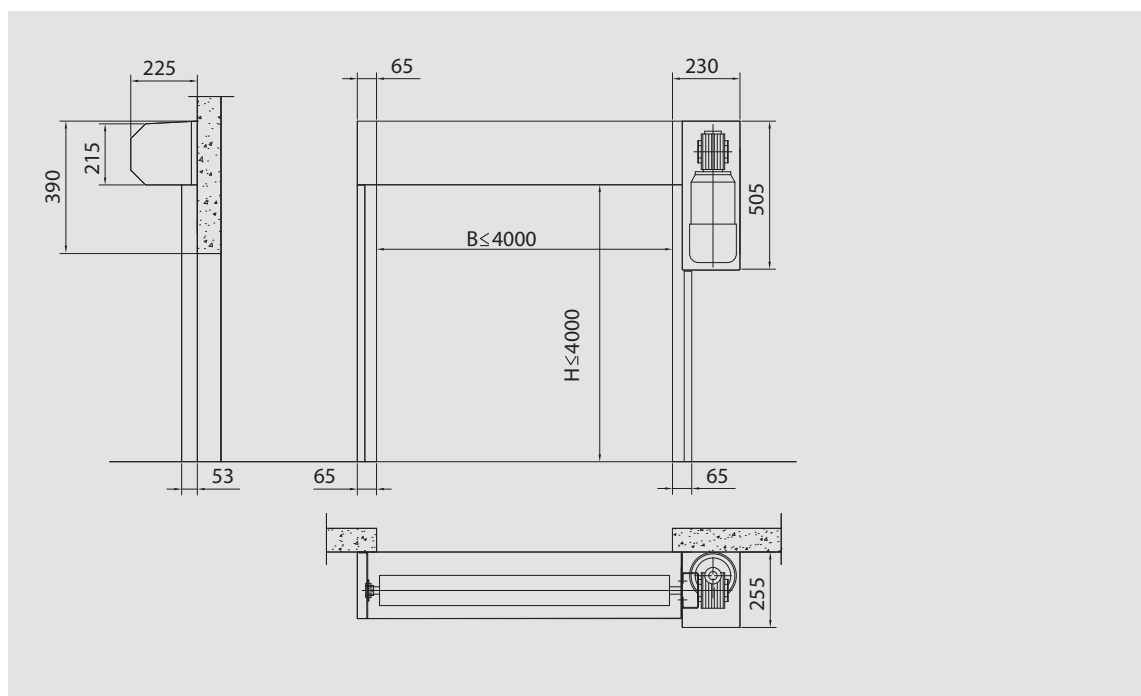



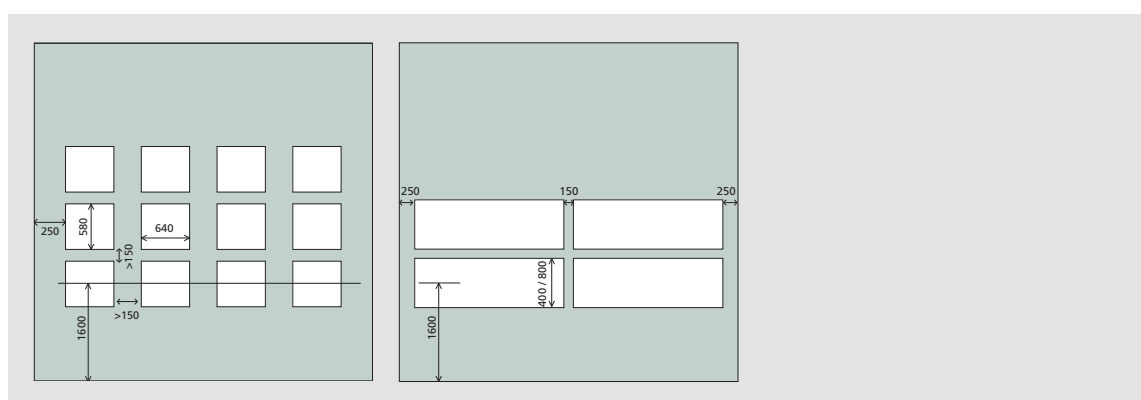



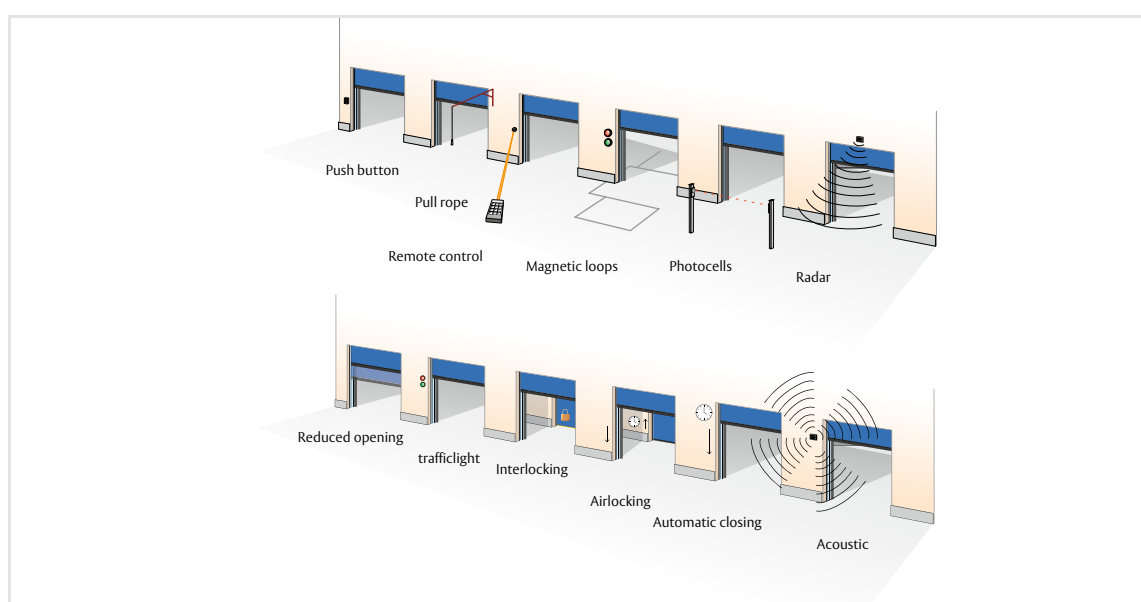



## Windows and Vision panels



## Options access and automation



## Standard available colours

 Signal yellow RAL 1003	 Ultramarine blue RAL 5002	 Anthracite grey RAL 7016	 Jet black RAL 9005
 Pure orange RAL 2004	 Gentian blue RAL 5010	 Light grey RAL 7035	 White RAL 9010
 Flame red RAL 3000	 Moss green RAL 6005	 Traffic grey B RAL 7043	 On request Other colors