

Product datasheet

High speed door

ASSA ABLOY HS9120GHY

ASSA ABLOY
Entrance Systems

Experience a safer
and more open world



Copyright and Disclaimer Notice

Although the contents of this publication have been compiled with the greatest possible care, ASSA ABLOY cannot accept liability for any damage that might arise from errors or omissions in this publication. We also reserve the right to make appropriate technical modifications/replacements without prior notice.

No rights can be derived from the contents of this document.

Color guides: Color differences may occur due to different printing and publication methods.

ASSA ABLOY as word and logo are trademarks belonging to the ASSA ABLOY Group.

No part of this publication may be copied or published by means of scanning, printing, photocopying, microfilm or any other process whatsoever without prior permission in writing by ASSA ABLOY.

© ASSA ABLOY 2006-2022.

All rights reserved.

Technical facts

Features

Area of use:	Inside
Structure:	Stainless steel AISI 304
Max size: (W x H)*	4000 mm x 4000 mm
Colors:	11 standard colors - white, yellow, green, orange, red, gray, traffic gray B, anthracite, black, blue, gentian blue
Safety:	Light curtain 1800 mm in side columns Photocells in side columns and soft bottom beam including wireless detection device for DH < 2100 mm (available as alternative on all dimensions)
Options:	Different vision and insect screen options are available. Color of drum cover, side column cover, motor cover.

* Other sizes may be available on request

Performance

Operating speed:	Opening: up to 1,2 m/s (optional 2,0 m/s) Closing: 0,5 m/s
Wind load resistance:	Class 1 (300 Pa (N/m ²)) maximum wind load while closing 50 N/m ² *
Water penetration:	Class 2 (50 Pa (N/m ²))*
Air permeability:	Class 1 (24 m ³ /m ² /h at 50 Pa)*
Thermal transmittance:	6,02 W/(m ² K)
Performance Test:	1.000.000 cycles
Temperature working range:	5 °C to +40 °C

* Not applicable for insect screens

Contents

Copyright and Disclaimer Notice.....	2
Technical facts.....	3
Features.....	3
Performance.....	3
1. Description.....	5
1.1. General.....	5
1.1.1. Standard.....	5
1.1.2. Options.....	5
1.2. Door curtain.....	6
1.2.1. Construction.....	6
1.2.2. Material.....	6
1.2.3. Colors.....	6
1.2.4. Windows, vision panels and insect screens.....	7
1.2.5. Self-reset system.....	7
1.2.6. Light curtain.....	7
1.2.7. Soft bottom beam.....	7
1.3. Side columns.....	8
1.3.1. General.....	8
1.4. Header box.....	8
1.4.1. Steel roll.....	8
1.4.2. Covers.....	8
2. Operating system.....	9
2.1. General.....	9
2.2. Operator.....	9
2.3. Control unit.....	9
2.4. Chain hoist.....	10
2.5. Access and automation.....	10
2.5.1. Basic control functions.....	10
2.5.2. External control functions.....	11
2.5.3. Automatic control functions.....	11
2.5.4. Safety functions.....	12
2.5.5. Lights.....	12
2.5.6. Additional functions.....	13
3. Specifications.....	14
3.1. Daylight width and height.....	14
3.2. Fabric specifications.....	14
3.3. Windows / insect screens.....	14
3.3.1. Required Daylight Width.....	14
3.3.2. Required Daylight Height.....	14
3.4. Vision / insect screen panels.....	15
3.4.1. 400 mm panel.....	15
3.4.2. 800 mm panel.....	15
4. CEN Performance.....	16
5. Building and space requirements.....	17
5.1. Building preparations.....	17
5.2. Space requirements.....	17
6. Service you can rely on.....	18
Index.....	19

1. Description

1.1 General

The ASSA ABLOY HS9120GHY high speed door is designed for interior applications. It offers perfect sealing thanks to a unique design. It requires very little space and protects your environment against drafts, humidity, dust and dirt. The operating speed combined with its sealing properties improves your traffic flow, provides employee comfort, and saves energy.

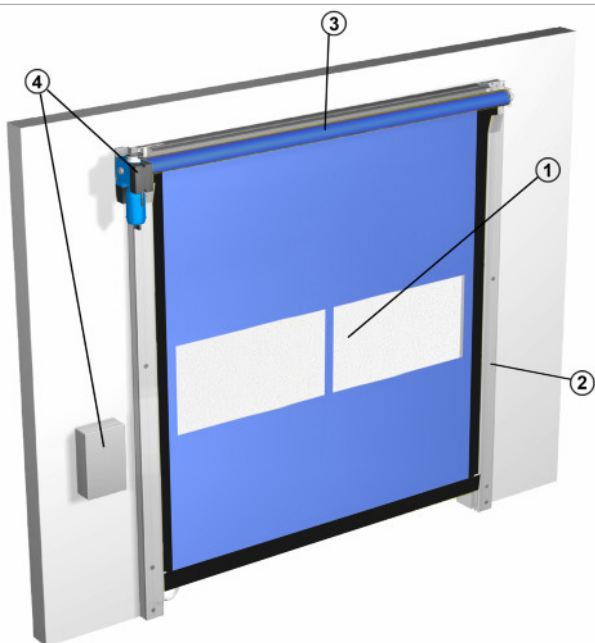

The ASSA ABLOY HS9120GHY high speed door has 4 primary parts:

- 1) Door curtain
- 2) Side columns
- 3) Header box
- 4) Operating system

1.1.1 Standard

The ASSA ABLOY HS9120GHY high speed door is supplied with the following specifications as standard:

Door curtain:	900 g/m ² colored PVC Self-reset function
Frame:	Stainless steel AISI 304
Safety:	Light curtain 1800 mm in side columns Photocells in side columns and soft bottom beam including wireless detection device for DH < 2100 mm (available as alternative on all dimensions)
Operation:	Operator + control unit
Colors:	11 standard colors - white, yellow, green, orange, red, gray, traffic gray B, anthracite, black, blue, gentian blue

1.1.2 Options

ASSA ABLOY provides a wide range of options and accessories to customise the ASSA ABLOY HS9120GHY high speed door to any customer's needs.

Header box:	Stainless steel AISI 304 drum cover Stainless steel AISI 304 operator cover
Side column:	Stainless steel AISI 304 side column covers
Operation:	Access and Automation
Vision / insect screens:	Small windows / insect screens Vision panels / insect screens

1.2 Door curtain

1.2.1 Construction

The door curtain is constructed from one single piece of PVC fabric. The door curtain rolls up above the door opening and requires little space.

Top

The top of the fabric is connected to a stainless steel roll, located in the header box above the door opening.

Bottom

The soft bottom beam of the door curtain does not contain any stiffeners, making the door curtain completely safe as it gives way should an obstruction be in the line of closing.

Side

The left and right sides of the door curtain are constructed with unique retaining straps that keep the door curtain tensioned under wind load, but minimises the friction of the door curtain through the side columns. If the door is hit by a vehicle, the retaining straps are pulled out of the side column. The self-reset function acts as a zipper to put the retaining straps back in the side column.











1.2.2 Material

Fabric type

- 900 g/m² colored PVC,
- high resistance

1.2.3 Colors

The ASSA ABLOY HS9120GHY high speed door is available in 11 fabric colors and translucent. The RAL-colors are as close as possible to the official RAL HR collection. Max. deviation is 1,0 DE.

	RAL 1003
	RAL 2004
	RAL 3000
	RAL 5002
	RAL 5010
	RAL 6005
	RAL 7016
	RAL 7035
	RAL 7043
	RAL 9005
	RAL 9010
	Translucent (option)

1.2.4 Windows, vision panels and insect screens

To increase the admission of daylight or to improve the visibility or airflow, the door curtain can be equipped with windows, vision panels or insect screens. Windows and insect screens have fixed sizes and are located on a pre-defined grid. A vision or insect screen panel is always located on the full width of the door curtain with its center height at the industry standard of 1600 mm.

Vision or insect screen panel



Windows or insect screens



1.2.5 Self-reset system

The high speed doors are equipped with an automatic reset system. If a door is hit by a vehicle during operation, the resistant door curtain absorbs the impact and releases itself from its side guides minimizing damage. The door reinserts itself automatically within the next open and close cycle. This unique feature makes the door crash-forgiving lessening damage, reducing production downtime and repair costs.

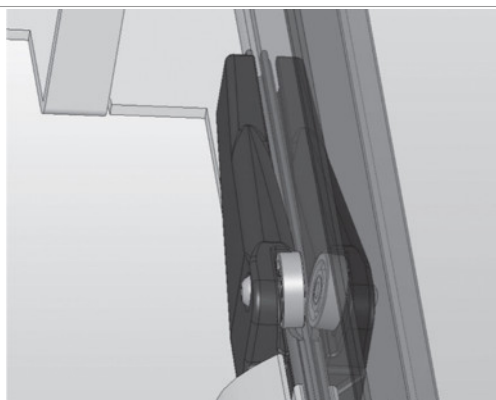

1.2.6 Light curtain

The light curtain is a safety device which allows you to avoid contact with a closing door in the whole width and up to 1.6 m in height.

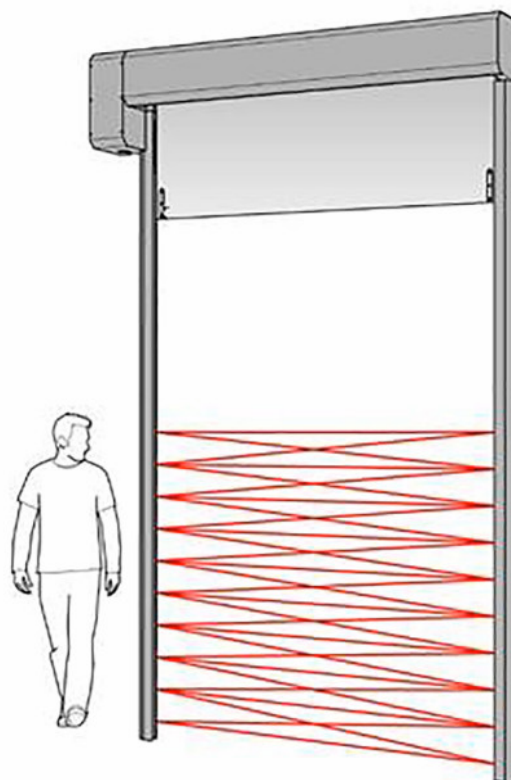

1.2.7 Soft bottom beam

The soft bottom beam is a flexible floor sealing that contains a wireless detection device. When the door is hit by a vehicle, the curtain dislocates from the side column and automatically resets itself immediately during movement or during the next opening cycle.



1.3 Side columns

The side columns guide the door curtain up and down. This guidance is a plastic-to-plastic connection, which makes lubrication essential.

1.3.1 General

The side columns are part of the frame that also contains the header box. This frame is made of a 3 mm thick stainless steel profile. The side columns are connected directly to the wall.

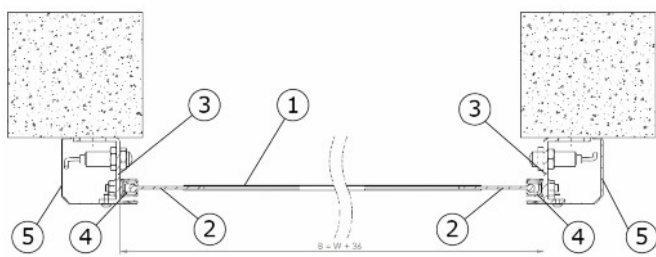

- 1) Door curtain
- 2) Lateral retaining strap (zipper)
- 3) Frame (37 mm x 52 mm x 3 mm folded steel)
- 4) Low-friction polyethylene side guide inside a steel rail
- 5) Cover (stainless steel)

1.4 Header box

1.4.1 Steel roll

The stainless steel roll is installed in the header box above the door curtain. Its function is to roll up or down the door curtain by means of the operating system. The door curtain is tensioned by its own fabric weight.



1.4.2 Covers

For use in dusty and dirty environments or for aesthetical reasons, an optional header box cover is available to enclose the fabric roll and the operator. Also the side columns can be equipped with covers. All the covers are in Stainless steel AISI 304.

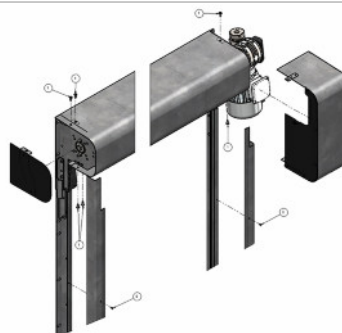

2. Operating system

2.1 General

The ASSA ABLOY high speed door is always operated electrically. The operating system is a combination of an operator and a control unit. The operator opens the door with an electric motor. The door closes under the weight of the door curtain. The control unit secures a safe closing speed.

2.2 Operator

Exceptional reliability and smooth operation is ensured by a motor driven by a frequency inverter. This technology ensures a soft start and stop, which increases the longevity of the motor considerably. It also allows faster opening/closing speed. This motor delivers reliable operations around-the-clock. The operator is always combined with a control unit.

The operator drives the steel roll to open or close the door. In case of a main supply failure, the operator can be disconnected and the door can be opened or closed manually using the hand crank.

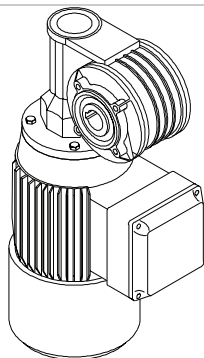

2.3 Control unit

The control unit is installed beside the door. It has impulse UP and DOWN buttons, an emergency stop button and a mechanical main switch.

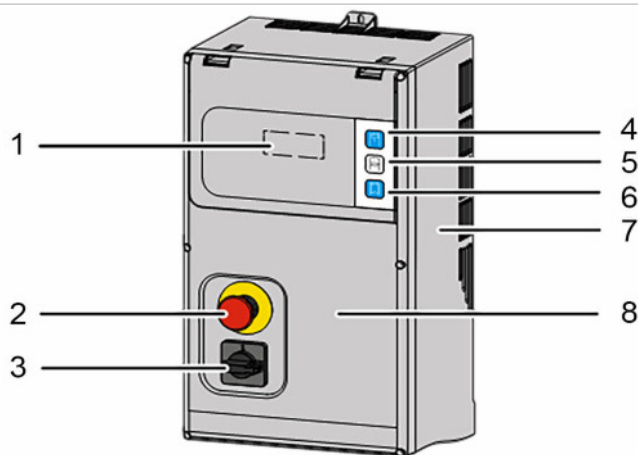

- 1) Display
- 2) Emergency stop
- 3) Mechanical main switch
- 4) UP button
- 5) STOP button
- 6) DOWN button
- 7) Housing
- 8) Housing cover

2.4 Chain hoist

A chain hoist makes it possible to manually operate the door, e.g. during a power failure. When the electrical operation is in use, the chain hoist is disconnected. When manual operation is required, pulling a string will connect the hoist to the motor while switching off the electrical power; this will allow safe manual operation of the door.

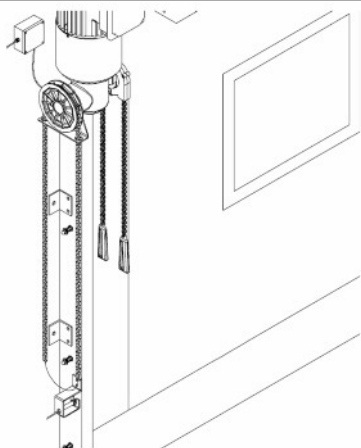

2.5 Access and automation

ASSA ABLOY offers a wide range of functions that allow advanced opening and safety control.

2.5.1 Basic control functions

2.5.1.1 Interlocking

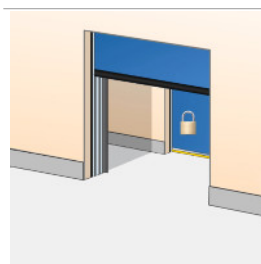

Developed for climate control or safety; If door A is open, door B cannot be opened. If door B is open, door A cannot be opened. An interlocked door can remember an up-command, if selected via a micro switch. Optionally an external locked switch can be installed to deactivate it.

- Function Interlock operating (switch interlock ON/OFF delivered with priority door)
- Switch interlock on/off (requires interlock function)
- Switch interlock on/off with key (requires interlock function)

2.5.1.1 Airlock

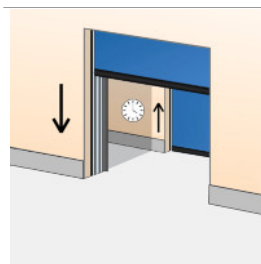

Developed for climate control or safety: Other than the interlock, door B will open automatically when door A is closed. Circuit card Installed in control unit. Optionally an external locked switch can be installed to deactivate it.

2.5.1.1 Reduced opening

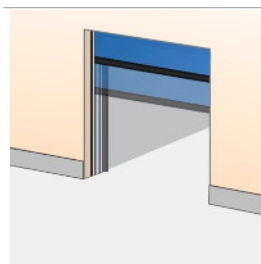

When people pass through the door, it may be unnecessary to fully open a door. A manual (pedestrian) command can trigger a reduced door opening, while a radar or magnetic loop still triggers a full door opening. Pre-fitted micro-switch to be activated in control unit.

- Function Two opening heights I/II with manual selection (switch included)
- Function Two opening heights I/II with automatic selection (2 different opening impulses)

2.5.2 External control functions

2.5.2.1 External push button box

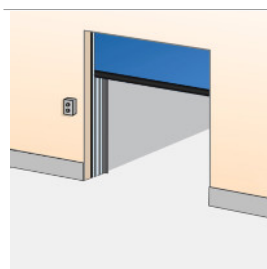

An extra control box is installed outside the building or inside close to the door if the main control unit needs to be installed away from the door opening. Usually combined with reduced opening. Installed on the inside or outside wall beside the door.

2.5.2.1 Pull-rope switch

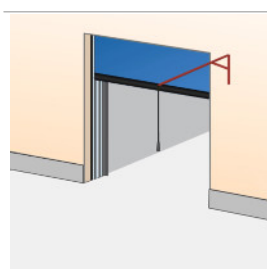

A pull-rope switch above the door opening can be operated from e.g. a forklift truck. Pulling the rope opens the door. Installed on the inside construction above the door.

- Pull down switch complete 5 m cord
- Pull switch bracket in stainless steel – L 3000 mm

2.5.2.1 Remote control

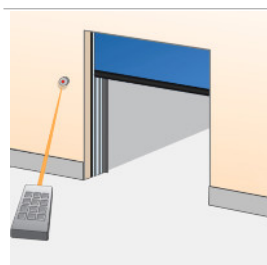

A hand-held radio transmitter allows door operation from a vehicle or any position within 50-100 meters from the receiver and aerial at the door. For closing, the door can be provided with a photocell beam. Receiver installed in control unit, antenna installed on the wall beside the door.

2.5.3 Automatic control functions

- Function Auto/Manual (includes switch on the control box)
- Function Manual closing with opening/closing using a common manual command (e.g. one single pull rope opens and closes the door)
- Function Manual closing with separate impulse (e.g. 2 buttons up and down)

2.5.3.1 Magnetic loop

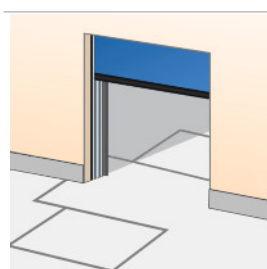

A sensor in the floor detects a metal object (usually forklift trucks, pallet trucks) and opens the door automatically. This is an ideal solution for frequent vehicle traffic. Installed on the outside, inside or both sides of the door in the floor.

2.5.3.1 Radar

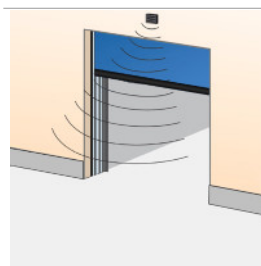

An infrared sensor above the door detects an object (person, vehicle) within a specified distance from the door and opens the door automatically. This is an ideal solution for frequent vehicle or personal traffic. Often combined with automatic closing. Installed on the inside or outside wall above the door.

2.5.3.1 Spot on

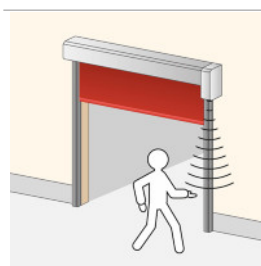

An infrared sensor can be installed to allow a contactless opening for passage of people. The sensor can be placed in the motor cover or an alternative support can be used to install the device anywhere. This is an ideal solution in an environment where, for hygiene reasons, people must avoid touching objects.

2.5.3.1 Photocell open door

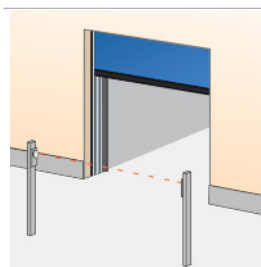

A set of photocells on pillars, on each side of the door. When a person or vehicle passes between the photocells, the beam is interrupted and the door opens. Photocells installed on pillars, away from the door.

2.5.3.1 Automatic closing (standard)

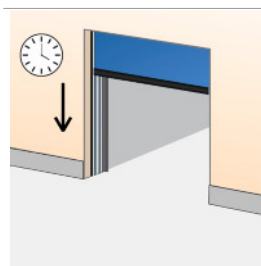

A programmable timer that closes the door after a specified time, counted from either the fully open position and/or from passing through the photocell beam. Usually also a switch on the control unit is used to turn to manual closing. Adjustable micro switches in control unit.

2.5.4 Safety functions

2.5.4.1 Safety light curtain (standard for $DH \geq 2100$)

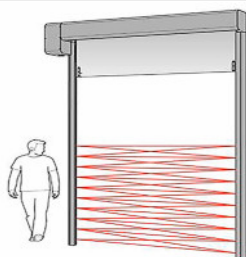

All doors are equipped with a safety light curtain. The light curtain is a safety device which allows you to avoid contact with a closing door in the whole width and up to 1.6 m in height. If any obstacle enters in the door area the door reverses.

2.5.4.1 Wireless detection device (standard for $DH < 2100$; optional on other dimensions)

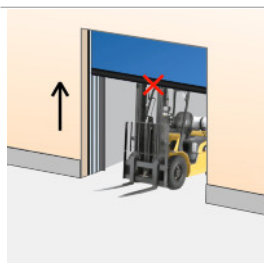

All doors are equipped with a detection device. A wireless detection device in the soft bottom beam detects any obstruction under a closing door and reverses the door.

2.5.4.1 Safety photocells 1-channel (standard for $DH < 2100$; optional on other dimensions)

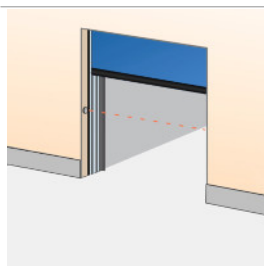

A set of a photocell transmitter and receiver is installed in the door opening. If the photocell beam is interrupted during closing, the door will stop in less than 30 mm and reverse to the fully open position. Installed in the door opening 300 mm from floor level.

2.5.4.1 Warning lights - Red

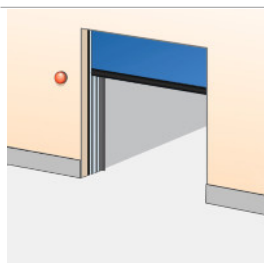

A red warning light on each side gives information on the current door behaviour. Flashing light seconds before and during door movement. Installed on the inside and outside wall beside the door.

2.5.4.1 Acoustic signal

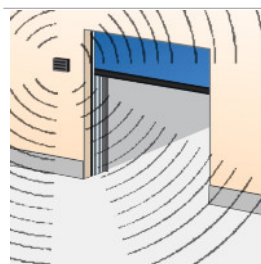

An acoustic signal is given, starting just before the door begins to close and continues until the door is fully closed. Installed on the inside and outside wall beside the door.

- Acoustic signal 24VAC 80 dB at 1 meter (horn when door is moving)

2.5.5 Lights

- Standard function flashing light
- Standard function flashing light with pre-warning before closing and opening

2.5.5.1 Warning lights - Orange

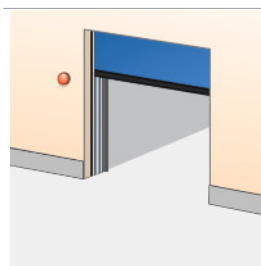

An orange warning light on each side gives information on the current door behaviour. Flashing light seconds before and during door movement. Installed on the inside and outside wall beside the door.

2.5.5.1 Warning lights - Green

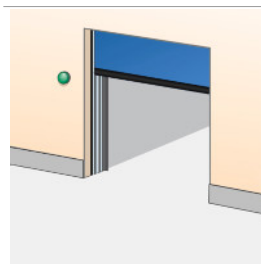

A green warning light installed on each side of the door indicating the open position of the door by continuous light signal.

2.5.5.1 Traffic lights - Red & Green

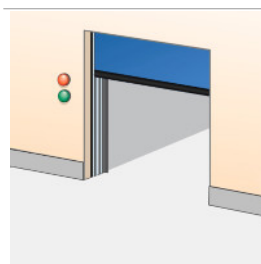

If traffic through a door needs to be directed; two red and two green traffic lights can be installed to indicate traffic direction. From the side where a vehicle is first detected to approach the door, the green traffic light comes on. The opposing side shows a red traffic light. Traffic from this direction must give way to the other. Usually installed in e.g. parking garages. Installed on the inside and outside wall beside the door.

2.5.6 Additional functions

2.5.6.1 UPS battery backup

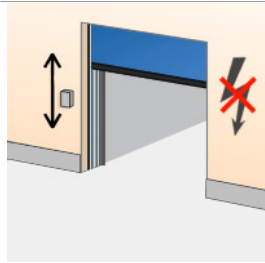

In case of main supply failure or emergency situations, it may be necessary to be able to open the door. The UPS battery stores enough power for one emergency opening cycle. Installed on the inside wall beside the door.

- Kit UPS Interface, automatic opening in case of power failure
- Kit UPS Interface, semi-automatic in case of power failure

3. Specifications

3.1 Daylight width and height

The standard ASSA ABLOY HS9120GHY high speed door is delivered in the following size range:

Standard door sizes*		
	Daylight width	Daylight height
Min.:	1000 mm	2000 mm
Max.:	4000 mm	4000 mm

* Other sizes may be available on request

3.2 Fabric specifications

	Colored fabric	Vision panel	Insect screen
Material	Reinforced PVC	PVC	PES
Thickness	0,8 mm	2,0 mm	-
Weight	900 g/m ²	2,5 kg/m ²	500 g/m ²
Tensile strength (kN/5cm)	4,0 L / 3,5 W	1,6	2,4
Tearing resistance	600 N (DIN 53363)	100 N (DIN 53515)	400 N (DIN 53363)

3.3 Windows / insect screens

Dimensions: W x H: 640 mm x 580 mm.
Combinations: Any combination of rows is possible.

3.3.1 Required Daylight Width

DLW	Available no. of columns
1140 mm – 1929 mm	1
1930 mm – 2719 mm	2
2720 mm – 3509 mm	3
3510 mm – 4000 mm	4

3.3.2 Required Daylight Height

DLH	Available no. of rows	CC
2040 mm	1	1600 mm
2770 mm	2	2330 mm
4000 mm	3	3060 mm

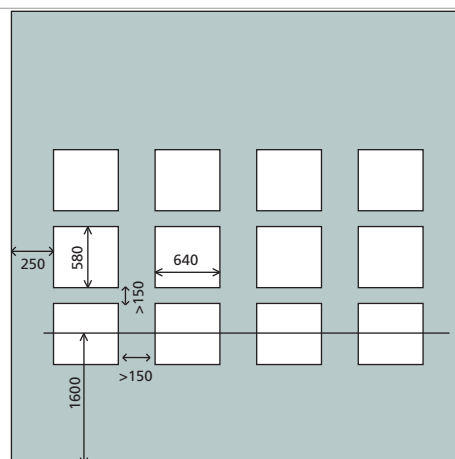

3.4 Vision / insect screen panels

A vision or insect screen panel can be installed at any DLW. At every 2444 mm DLW, the vision panel will be fitted with a vertical reinforcement strip. Vision panels are available in 400 mm and 800 mm height.

3.4.1 400 mm panel

Daylight Height	Available no. of panels	CC
< 1950 mm	1	1600 mm
≥ 2500 mm	2	2150 mm

3.4.2 800 mm panel

Daylight Height	Available no. of panels	CC
< 2150 mm	1	1600 mm
≥ 3100 mm	2	2550 mm

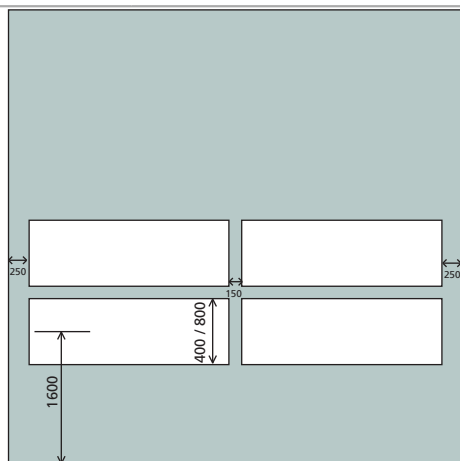

4. CEN Performance

Characteristic	Standard	Test acc.	Result	Value
Wind load	EN 12424	EN 12444	Class 1*	300 Pa (N/m ²)
Water permeability	EN 12425	EN 12489	Class 2*	50 Pa (N/m ²) water spray for 15 minutes
Air permeability	EN 12426	EN 12427	Class 1*	24 m ³ /m ² /h at 50 Pa
Safe openings	EN 12453	EN 12445	Pass	
Mechanical resistance	EN 12604	EN 12605	Pass	
Unintended movements	EN 12604	EN 12605	Pass	
Thermal resistance	EN 12428		6,02 W/(m ² K)	
Performance Test	EN 12604	EN 12605	1.000.000 cycles	

* Not applicable for insect screens

5. Building and space requirements

5.1 Building preparations

The door is pre-assembled in the factory as much as possible to ensure that installation can be carried out easily and quickly. The door is installed directly on the wall. A forklift truck is needed to raise the frame to the wall.

The fixation of the wall must be of an adequate strength to sustain the wind load as well as the blow of a collision.

The following environment criteria and electrical supplies are required for the operator to function properly:

Voltage supply:	220V - 240V 1-phase
Power:	0.75kW 16A
Frequency:	50Hz - 60Hz
Degree of protection:	Operator: IP65 Control unit: IP65
Temperature working range:	5 °C to +40 °C

5.2 Space requirements

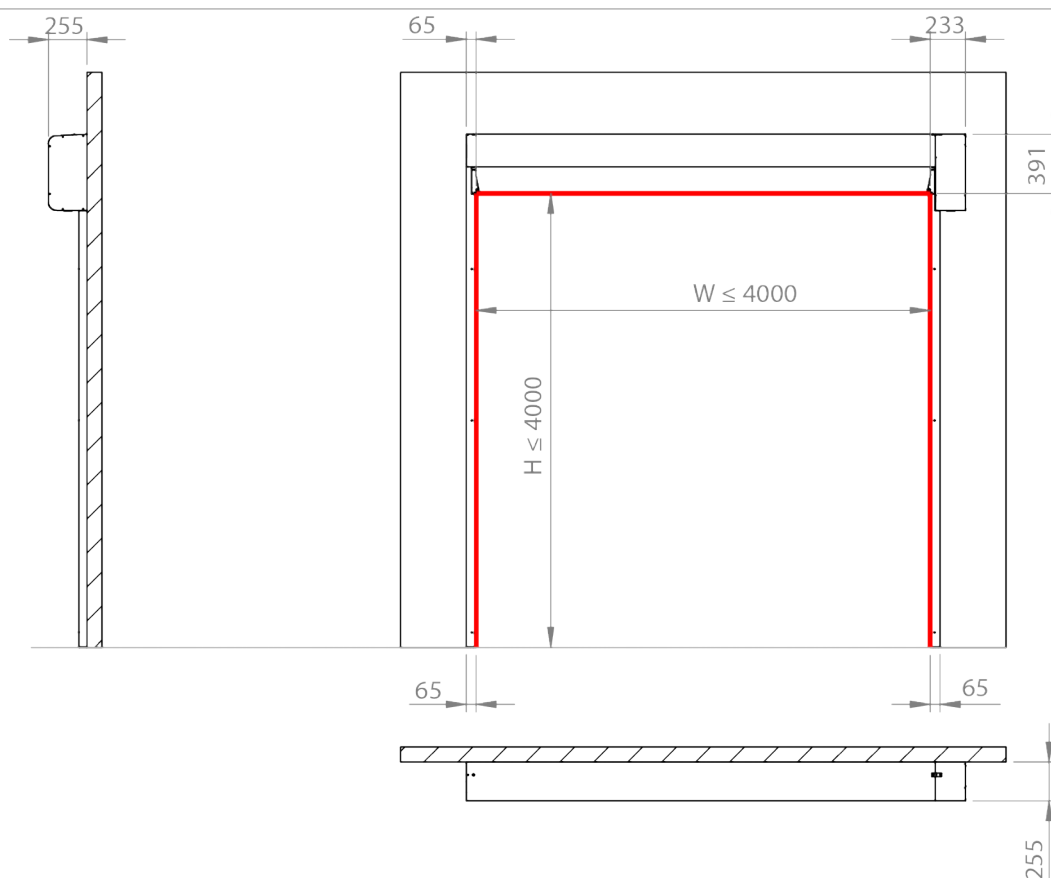

6. Service you can rely on



Gold

The ultimate protection

With full coverage, Gold Service enables you to plan and budget your expenses annually.

- Spare parts for emergency calls
- Labor and travel costs for emergency calls
- Replacement of components according to preventive maintenance schedule and to fulfill legislative and safety requirements

Silver

Added advantages

With cover for all service calls during business hours, Silver Service offers you peace of mind.

- Labor and travel costs for emergency calls
- Preventive maintenance

Bronze

Scheduled Service

With scheduled on site visits, Bronze Service means you know that your doors and docking systems will be regularly serviced and inspected.

- Preventive maintenance

Included in all packages

1-4 scheduled maintenance visits per year	24/7 priority service hotline and fast response	Safety, compliance and quality control checks	Documentation reports provided on site
-------------------------------------------	-------------------------------------------------	-----------------------------------------------	----------------------------------------

Expert service you can rely on

A healthy business enjoys a steady flow of goods, services and people through its entrances every day. But heavy traffic puts entrances under pressure as every component works to keep them running.

ASSA ABLOY Entrance Systems offer the industry's most complete, flexible service solutions. Because even something as robust and well-engineered as an ASSA ABLOY door or docking system needs to be serviced to stay in great working order.

Pro-active care packages

An ASSA ABLOY service agreement gives you service you can rely on. We have specialized local service technicians on call to take care of your service needs. Equipped with a wide range of spare parts and expertise, to keep your industrial doors and docking systems running.

With an ASSA ABLOY service agreement you can ensure reliable, safe and sustainable operations at every entrance under your agreement, including doors and docking systems, independent of brand.

ASSA ABLOY e-maintenance™ (optional add-on)

For an online overview of your entrance systems and history, add ASSA ABLOY e-maintenance™ to your service package for:

- Easy access to real-time data on all your doors
- Planning, order and service information
- Overview that helps you control lifecycle costs

Index

4		
400 mm panel.....	15	
8		
800 mm panel.....	15	
A		
Access and automation.....	10	
Acoustic signal.....	12	
Additional functions.....	13	
Airlock.....	10	
Automatic closing (standard).....	11	
Automatic control functions.....	11	
B		
Basic control functions.....	10	
Building and space requirements..	17	
Building preparations.....	17	
C		
CEN Performance.....	16	
Chain hoist.....	10	
Colors.....	6	
Construction.....	6	
Control unit.....	9	
Copyright and Disclaimer Notice...	2	
Covers.....	8	
D		
Daylight width and height.....	14	
Description.....	5	
Door curtain.....	6	
E		
External control functions.....	11	
External push button box.....	11	
F		
Fabric specifications.....	14	
Features.....	3	
G		
General.....	8, 9	
General.....	5	
H		
Header box.....	8	
I		
Interlocking.....	10	
L		
Light curtain.....	7	
Lights.....	12	
M		
Magnetic loop.....	11	
Material.....	6	
O		
Operating system.....	9	
Operator.....	9	
Options.....	5	
P		
Performance.....	3	
Photocell open door.....	11	
Pull-rope switch.....	11	
R		
Radar.....	11	
Reduced opening.....	10	
Remote control.....	11	
Required Daylight Height.....	14	
Required Daylight Width.....	14	
S		
Safety functions.....	12	
Safety light curtain (standard for DH \geq 2100).....	12	
Safety photocells 1-channel (standard for DH<2100; optional on other dimensions).....	12	
Self-reset system.....	7	
Service you can rely on.....	18	
Side columns.....	8	
Soft bottom beam.....	7	
Space requirements.....	17	
Specifications.....	14	
Spot on.....	11	
Standard.....	5	
Steel roll.....	8	
T		
Technical facts.....	3	
Traffic lights - Red & Green.....	12	
U		
UPS battery backup.....	13	
V		
Vision / insect screen panels.....	15	
W		
Warning lights - Green.....	12	
Warning lights - Orange.....	12	
Warning lights - Red.....	12	
Windows / insect screens.....	14	
Windows, vision panels and insect screens.....	7	
Wireless detection device (standard for DH<2100; optional on other dimensions).....	12	

The ASSA ABLOY Group is the global leader in access solutions.
Every day, we help billions of people to experience a more open world.

ASSA ABLOY
Entrance Systems

ASSA ABLOY Entrance Systems provides solutions for efficient and safe flow of goods and people. Our offering includes a wide range of automated pedestrian, industrial and residential doors, loading dock equipment, perimeter fencing and service.

Follow us:



Please enter ASSA ABLOY Entrance
in the channel's search field.