

User Manual

Swing Door Operator

ASSA ABLOY SW100

ASSA ABLOY
Entrance Systems

Experience a safer
and more open world

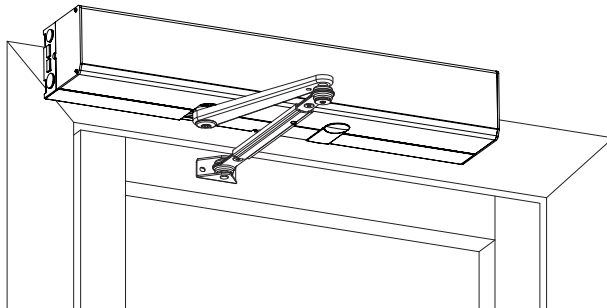

CONTENTS - Original instructions

Instructions for safe operation	3
Congratulations on your new automatic door!	4
Electronic equipment reception interference	4
Environmental requirements	4
Product liability	4
Warranty	5
Service	5
Intended use	6
Technical specification	6
How the ASSA ABLOY SW100 works	7
Regular safety checks	8
General accessories	11
Safety accessories	11
Troubleshooting	11
Service/Maintenance	12
Other products from ASSA ABLOY Entrance Systems	12
Declaration of conformity	13

ASSA ABLOY as word and logo are trademarks owned by the ASSA ABLOY Group

© ASSA ABLOY Entrance Systems, 2021

Technical data subject to change without notice.

Backtrack information: folder:Workspace Main, version:a656, Date:2021-04-16 time:09:53:06, state: Frozen

Instructions for safe operation



- Failure to observe the information in this manual may result in personal injury or damage to equipment.
- To reduce the risk of injury to persons - use this operator with single or double pedestrian swinging or folding doors only.
- Do not use the equipment if repair or adjustment is necessary.
- Disconnect supply when cleaning or other maintenance is to be carried out.
- The operator can be used by children over 8 years of age if they have been instructed by a person in charge of their safety.
- The operator can be used by children 8 years of age or younger if they are supervised by a person responsible for their safety.
- The operator can be used by persons with impaired physical, sensory or mental capacity if they have been instructed by a person in charge of their safety.
- Cleaning and user maintenance shall not be made by children.
- Do not let anyone climb on or play with the door or the fixed/remote controls.
- The doorset can be operated automatically by sensors or manually by activators. It can also be used manually as a door closer.

Congratulations on your new automatic door!

ASSA ABLOY Entrance Systems AB has developed automatic doors for more than 50 years. State-of-the-art technology and carefully tested materials and components provide you with a superior product.

As with all other technical products, your automatic door requires periodic maintenance and service. It is essential that you know your automatic door (system) and that you recognize the importance of maintaining it in compliance with applicable standards for safety.

Your local ASSA ABLOY Entrance Systems-authorized representative is familiar with these standards, as well as applicable local codes and ASSA ABLOY Entrance Systems recommendations for power-operated pedestrian doors. Service and adjustments performed by your ASSA ABLOY Entrance Systems-authorized representative, will ensure safe and proper operation of your automatic door unit.

Electronic equipment reception interference

The equipment may generate and use radio frequency energy and if not installed and used properly, it may cause interference to radio, television reception or other radio frequency type systems.

If other equipment does not fully comply with immunity requirements, interference may occur.

There is no guarantee that interference will not occur in a particular installation. If this equipment does cause interference to radio or television reception, which can be determined by turning the equipment off and on, the user is encouraged to try to correct the interference by one or more of the following measures:

- Re-orient the receiving antenna.
- Relocate the receiver with respect to the equipment.
- Move the receiver away from the equipment.
- Plug the receiver into a different outlet so that equipment and receiver are on different branch circuits.
- Check that protective earth (PE) is connected.

If necessary, the user should consult the dealer or an experienced electronics technician for additional suggestions.

Environmental requirements

ASSA ABLOY Entrance Systems products are equipped with electronics and may also be equipped with batteries containing materials which are hazardous to the environment. Disconnect power before removing electronics and battery and make sure it is disposed of properly according to local regulations (how and where) as was done with the packaging material.

Product liability

According to regulations, the following are the responsibility of the owner or caretaker of the equipment

- that the equipment operates correctly, so that it gives sufficient protection in regard to safety and health
- that the equipment is operated and regularly maintained, inspected and serviced by someone with documented competence in the equipment and in applicable regulations
- that the provided "Service Log Book" and "Site Acceptance Test and Risk Assessment" documents (PRA-0007) are kept available for maintenance and service records
- that inspection covers the emergency opening function (when applicable)
- that the closing force is appropriate for the door size on fire-approved door systems (when applicable).

Warranty

ASSA ABLOY Entrance Systems warrants its products to be free from defects in material and workmanship under intended use and service for a warranty time of 12 months, beginning at time of delivery. This warranty extends only to the original buyer of the equipment.

ASSA ABLOY Entrance Systems warrants that the software will operate substantially in accordance with its functional descriptions and that it has been recorded on non-defective media.

The ASSA ABLOY Entrance Systems warranty does not apply to

- That the software will be error-free or operate without interruption
- General wear and tear on the system
- Fuse, disposable batteries and glass damage
- System deviations caused by installer other than ASSA ABLOY Entrance Systems
- System that has been altered or damaged by vandalism or misuse
- System that has been additionally equipped with non-ASSA ABLOY Entrance Systems original branded parts and/or spare parts
- Unrequired visits due to poor client communication (door working when our technician arrives, reset, power discontinuation)
- Adjustments (closing and opening speed and also detection field radars) due to customer requests (excludes operational adjustments thought to create a hazard)
- Water damage
- Adverse weather conditions
- Any damage caused, directly or indirectly, by a circumstance beyond the control of the applicable company within ASSA ABLOY Entrance Systems, such as industrial dispute, fire, natural disaster, war, extensive military mobilization, insurrection, requisition, seizure, embargo, restrictions in the use of power and defects or delays in deliveries by sub-contractors caused by any such circumstances

Please note:

- Non-compliance with manufacturers care and maintenance recommendations may void the warranty.
- ASSA ABLOY Entrance Systems-authorized resellers shall extend this warranty to end-users only, but have no authority to extend a greater or different warranty on behalf of ASSA ABLOY Entrance Systems.
- A service agreement with ASSA ABLOY Entrance Systems will help secure the availability of a fully operational system and will give priority at call-out, thus minimizing the time that the equipment is unusable.

Service

Inspections should be done regularly by a trained and qualified person. The frequency of these inspections should be according to national regulations (or according to industry standard if there are no national regulations). This is especially important when the installation concerns a fire-approved door or a door with an emergency-opening function. To extend the life of your investment and ensure safe and reliable operation of the door, we recommend a minimum of 2 visits per year or more, depending on usage and operating conditions. Environmental aspects shall also be considered.

As your entrances are part of your business flow, there's every reason to keep them working well. ASSA ABLOY Entrance Systems offers you a maintenance and modernization expertise to rely on. Our Maintenance Programs and Modernization Services for entrance automation is backed by a extensive expertise for all types of pedestrian- and industrial door and docking systems, independent of brand. At your disposal is a team of dedicated expert technicians, proven through decades of maintenance, service and satisfied customers.

Intended use

The ASSA ABLOY SW100 is an automatic swing door operator developed to make life easier for everyone who can benefit from automatic doors. The ASSA ABLOY SW100 is a low-energy operator using a DC motor and a gear-reduction system to drive an arm system, which opens the door. It is to be installed indoors where it is suitable for almost all types of external and internal swing doors. This widely-used operator can be found in applications in health care, residential, office and public buildings.

The door is designed to offer continuous use, a high degree of safety and maximum lifetime. The system is self-adjusting to the effects caused by normal variations in the weather conditions and to minor friction changes caused by e.g. dust and dirt.

For escape in emergency situations the doorset is opened manually.

For installation and maintenance see Installation and Service manual 1005088.

Save these instructions for future reference.

Technical specification

Manufacturer:	ASSA ABLOY Entrance Systems AB
Address:	Lodjursgatan 10, SE-261 44 Landskrona, Sweden
Type:	ASSA ABLOY SW100
Mains power supply:	100-240 V AC +10/-15%, 50/60 Hz
Power consumption:	Max. 75 W
Class of protection:	IP20
Sound pressure:	$L_{pa} \leq 70 \text{ dB}(A)$
Approvals:	Third party approvals from established certification organizations valid for safety in use, see Declaration of Conformity.





How the ASSA ABLOY SW100 works

The swing door operator ASSA ABLOY SW100 uses a DC motor and a gear-reduction system to drive an arm system which opens the door. Closing power is provided by a motor and a closing spring. A highly sophisticated electronic control unit uses a motor encoder and a microprocessor to control the door's movement.

To activate the operator you can use a manual activator (elbow switch) or an automatic activator (radar device). It is also possible – where local standards allow – to activate the operator by just pushing the door, if Push & Go is selected.

After the door has been activated it will open and stay open for a specified Hold Open Time (HOT). When the HOT has elapsed the door will close.

The ASSA ABLOY SW100 can be set in three or four different modes, depending on programme selector type, see table below.

Position	Function
 AUTO Normal position	The door can be opened with the inner and outer manual and/or automatic activators. The electric strike, if fitted, is open.
 OFF	The door is closed. The door cannot be opened with inner and outer activation units. The door is locked if an electromechanical locking device has been fitted. The door can be opened with a key switch (if fitted).
 OPEN	The door is held permanently open and the motor is inactivated.
 EXIT	Passage from inside only. The door is normally locked if an electromechanical locking device has been fitted. The door can only be opened with the inner activation unit and with a key switch (if fitted).











Regular safety checks

To help you fulfill the national/international requirements and to avoid malfunction and risk for injuries, we have provided the following checklist.



Do not use the operator if repair or adjustment is necessary.

Disconnect supply ¹⁴ when cleaning or other maintenance is to be carried out.

Daily Action		If problem occurs	
Activate your operator and check <i>visually</i> , fastening and any damage of <ul style="list-style-type: none"> • operator ¹ • arm system ² • cables ³ • control switch ⁴ • hinges ⁵ • door and glass ⁶ 			
Also inspect your operator and check <i>visually</i> for <ul style="list-style-type: none"> • sharp edges on the door leaf and door frame (if any) ⁷ • condition of door seals ⁸ • finger protection ⁹ • and finally that the complete door runs properly and closes slowly in a smooth way 		 	
Set the mode selector to OFF and check that the operator and electromechanical lock (if fitted) work together. Also check that the lock ¹⁰ really secures the door.			
Activate the manual activation units ¹¹ , if any, and walk towards the door. Check that the door has opened appropriately while you pass the entrance/exit. Then proceed with the automatic activation units ¹² in the same way.			
Check the safety sensors ¹³ if any, by standing in the swing path and activate the operator. The door must not hit you when opening nor when closing. If you are unsure of which type of sensor you have, please contact your ASSA ABLOY Entrance Systems representative.			
Escape doors	By law, these tests must be performed regularly by trained personnel.	Set the programme selector in AUTO mode. Push the door manually in escape direction and make sure that no object or function will prevent the door from opening. Also make sure the escape route is free for use.	 
Fire doors		Let the door close after an impulse ensuring nothing prevents the door from closing and locking (if regulations require it).	 



= Take appropriate measures.



= Contact your ASSA ABLOY Entrance Systems representative. For contact information, see last page.

FUNCTION AND VISUAL INSPECTION

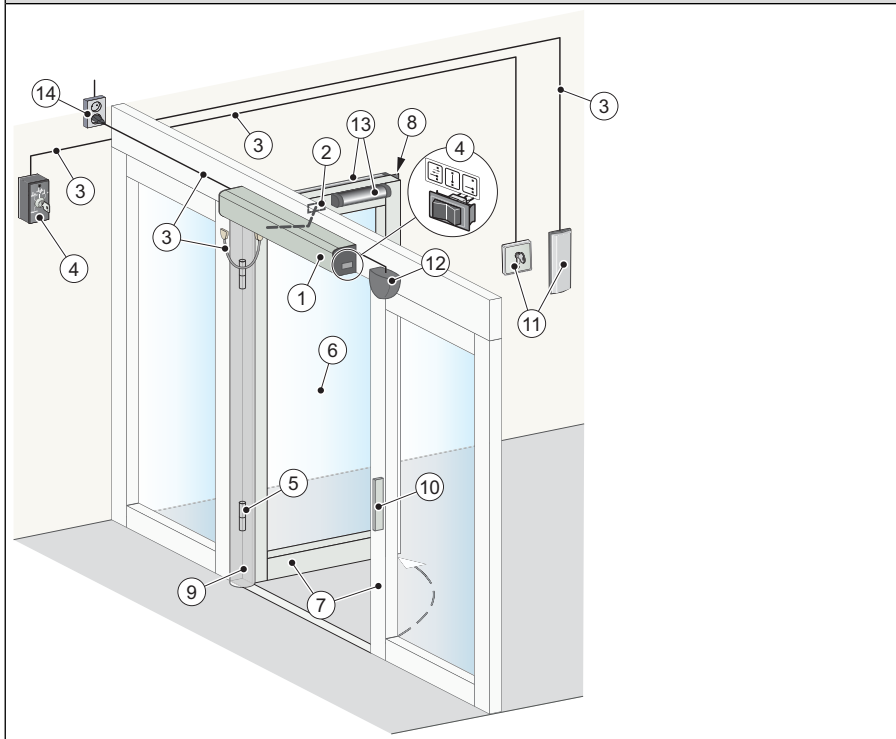

CLEANING

The best way to remove dust and dirt from the ASSA ABLOY SW100 is to use water and a soft cloth or a sponge. A gentle detergent may be used. To maintain the quality of the surface treatment, the surfaces should be cleaned once/four months period. The cleaning should be documented. To avoid damages to the profiles the brushes/weather stripping must be vacuum-cleaned weekly.

- Do not expose windows, doors or profiles to alkalis. Both aluminium and glass are sensitive to alkalis.
- Do not clean with high pressure water. Operator, mode selector and sensor may be damaged and water may enter the profiles.
- Do not use polishing detergent.
- Do not scrub with materials like Scotch-brite, as this will cause mechanical damage.

SIGNAGE



Action		If problem occurs
Check that all required signage is applied and intact. Mandatory indicates that the signage is required by European directives and equivalent national legislation outside the European Union.		
(A)	Product label: Mandatory	
(B)	Emergency break-out: Mandatory, if approved for escape route.	
(C)	ASSA ABLOY Entrance Systems door sticker: Mandatory, if applicable to highlight the presence of the glass (applied to all glass sections that are moving).	
(D)	Supervision of child (applied to both sides of the door): Mandatory according to national regulations. Recommended, if the risk analysis shows use by children.	
(E)	Operator designed for disabled people: Recommended, if applicable (applied to both sides of the door).	
(F)	Activation by disabled people: Recommended, if applicable.	
(G)	No entry, identifying one-way traffic: Mandatory in GB and US, if applicable, not included in the product.	
(H)	Automatic door	
(J)	Keep clear	
(K)	SITAC label: Mandatory in SE	

 = Contact your ASSA ABLOY Entrance Systems service representative. For contact information, see last page.

General accessories

- Control switch ④, [see page 9](#)
- Electrical lock ⑩, [see page 9](#)
- Key switch ⑪, [see page 9](#)
- Elbow switch ⑪, [see page 9](#)
- Radar ⑫, [see page 9](#)
- Wireless transmitters (not illustrated)
- Access control (not illustrated)
- Door stop (not illustrated)

Safety accessories

- Safety sensors ⑬, [see page 9](#).
- Finger protection ⑨, [see page 9](#).

Troubleshooting

What's wrong?	Remedies
The door does not open	
The motor does not start	Change the setting of the mode selector. (See page 7).
	Check that there are no objects in the detection zone if a sensor is fitted.
	Check the mains power and fuse in the building.
The motor starts but door(s) will not open	Unlock the mechanical locks.
	Check that nothing is jammed beneath the door.
The door does not close	Change the setting of the mode selector. (See page 7).
	Check that there are no objects in the detection zone if a sensor is fitted.
	Check that nothing is jammed beneath the door.
The door opens and closes continuously	Check that there are no moving objects within 1-1.5 m (39"-59") from the door if an automatic activation unit is fitted.
If the problem continues, please contact your ASSA ABLOY Entrance Systems representative.	

Service/Maintenance

Service and adjustments performed by your ASSA ABLOY Entrance Systems-authorized representative will ensure safe and proper operation of your automatic door unit.

Remember to keep “Service Log Book” and “Site Acceptance Test and Risk Assessment” documents (PRA-0007) available. These are used together.

The table below shows the recommended interval in months, when to replace parts during preventive maintenance. Talk to your ASSA ABLOY Entrance Systems representative to learn more about our service offering.

Part	Part number	Cycles/hour in operation			Abusive Environment
		<10	<100	>100	
		Low traffic	Medium traffic	High traffic	
PUSH/PUSH-335 service kit	330000271BK/SI	24	12	6	6
PULL/PULL-220 service kit	330000335BK/SI	24	12	6	6
Door stop (transmission unit until w.1927)	330000230	24	12	6	6
Stop arm kit (transmission unit from w.1927)	331019378	24	12	6	6
ST-V/H service kit	331003887	24	12	6	6
Micro switch kit	331019159	24	12	6	6
Battery backup unit	331003567	24	24	24	24
CU-ESD control unit	331003532	60	60	60	60

Other products from ASSA ABLOY Entrance Systems

- Door Systems
- Balance doors
- Air curtains
- Revolving doors
- Sliding doors
- Automatic and manual activation units
- Overhead sectional doors
- Service such as preventive maintenance and upgrade programs, emergency repairs, service advice and door management
- Vertical lifting fabric doors
- Dock levelers
- Dock shelters
- Folding doors
- High speed doors
- Loadhouses

Declaration of conformity

ASSA ABLOY
Entrance Systems

Experience a safer
and more open world

We **ASSA ABLOY Entrance Systems AB**
Lodjursgatan 10
SE-261 44 Landskrona
Sweden

declare under our sole responsibility that the type of equipment:
SW100

complies with the following directives:

2014/30/EU ElectroMagnetic Compatibility Directive (EMCD)

2006/42/EC Machinery Directive (MD)

2011/65/EU on the restriction of the use of certain hazardous substances in electrical and electronic equipment with the applicable amendments (RoHS)

Harmonized European standards which have been applied:

EN ISO 13849-1:2015

EN 60335-1:2012+A11:2014

EN 60335-2-103:2015

EN 61000-6-2:2005

EN 61000-6-3:2007+A1:2011

EN 16005:2012/AC:2015

Other standards or technical specifications, which have been applied:

FCC 47 CFR Part 15 B

UL 325

IEC 60335-1 ed 5:2010

IEC 60335-2-103: ed. 2.1:2011

EN 1634-1:2008

Certificate issued by a notified or competent body (for full address, please contact ASSA ABLOY Entrance Systems AB) concerning the equipment:

SC0839-09

UL File E47833

UL File R9469

The manufacturing process ensures the compliance of the equipment with the technical file. The manufacturing process is regularly assessed by 3rd party.

The CE mark was first applied 2007-10-01.

Compilation of technical file:

Anders Forslind

ASSA ABLOY Entrance Systems AB

Lodjursgatan 10

SE-261 44 Landskrona

Sweden

Place
Landskrona

Date
2021-04-16

Signature
Klas Hagelin

Position
Global Quality Manager



DoC 1005118-en-14.0

ASSA ABLOY Entrance Systems is a leading supplier of entrance automation solutions for efficient flow of goods and people. Building on the long-term success of the Besam, Crawford, Albany and Megadoor brands, we offer our solutions under the ASSA ABLOY brand. Our products and services are dedicated to satisfying end-user needs for safe, secure, convenient and sustainable operations. ASSA ABLOY Entrance Systems is a division within ASSA ABLOY.

assaabloyentrance.com



ASSA ABLOY Entrance Systems

Tel: +46 10 47 47 000
info.aes@assaabloy.com
assaabloyentrance.com