

User Manual

Revolving Door

ASSA ABLOY UniTurn (CDC 4)

ASSA ABLOY
Entrance Systems

Experience a safer
and more open world

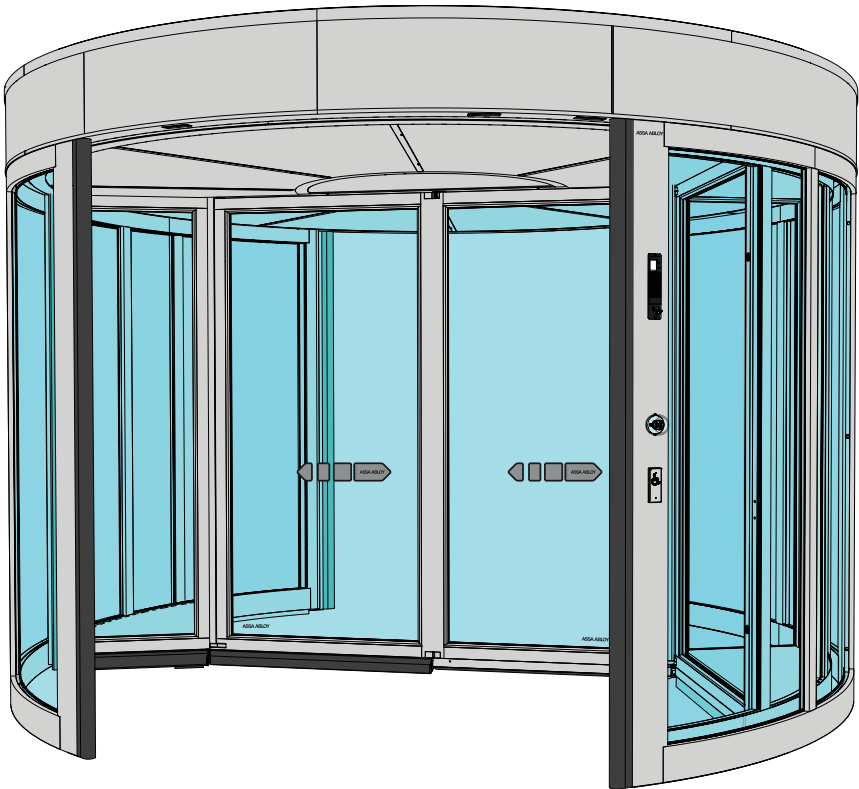

CONTENTS - Original instructions

Instructions for safe operation	4
Congratulations on your new automatic door!	5
Electronic equipment reception interference	5
Environmental requirements	5
Product liability	5
Warranty	6
Service	6
Intended use	7
Technical specification	7
How the ASSA ABLOY UniTurn works	7
Main parts	8
Settings and operation PCD	9
General information PCD	9
Information prompts on PCD display	9
Access code	10
Changing operating mode	11
Real time operation	14
Safety	17
Safety devices on the door	17
Emergency operation	19
Regular safety checks	21
Troubleshooting	24
Supervision system	24
Code list	25
Service/Maintenance	26
Service request	26
Remote Control Operation	27
Software communication	27
Communication ON/OFF	28
Login	28
Logout	28
Main menu	28
Door operation	29
Other information on screen	29

Options	30
Emergency stop button on the outside	30
Lock system	30
Automatic sliding centre door leaves	31
Reception panel	32
Extra PCD	32
Climate control	33
Quick guide changing operating mode	34
Other products from ASSA ABLOY Entrance Systems	35
Declaration of conformity	36

ASSA ABLOY as word and logo are trademarks owned by the ASSA ABLOY Group

© ASSA ABLOY Entrance Systems, 2020

Technical data subject to change without notice.

Backtrack information: folder:Workspace Main, version:a620, Date:2020-10-09 time:06:38:32, state: Frozen

Instructions for safe operation



- Failure to observe the information in this manual may result in personal injury or damage to equipment.
- To reduce the risk of injury of persons - use this door set only as a pedestrian door.
- Do not use the equipment if repair or adjustment is necessary.
- Disconnect supply when cleaning or other maintenance is to be carried out.
- The operator can be used by children over 8 years of age if they have been instructed by a person in charge of their safety.
- The operator can be used by children 8 years of age or younger if they are supervised by a person responsible for their safety.
- The operator can be used by persons with impaired physical, sensory or mental capacity if they have been instructed by a person in charge of their safety.
- Cleaning and user maintenance shall not be made by children.
- Do not let anyone climb on or play with the door or the fixed/remote controls.
- The doorset can be operated automatically by sensors or manually by activators.

Congratulations on your new automatic door!

ASSA ABLOY Entrance Systems AB has developed automatic doors for more than 50 years. State-of-the-art technology and carefully tested materials and components provide you with a superior product.

As with all other technical products, your automatic door requires periodic maintenance and service. It is essential that you know your automatic door (system) and that you recognize the importance of maintaining it in compliance with applicable standards for safety.

Your local ASSA ABLOY Entrance Systems-authorized representative is familiar with these standards, as well as all applicable local codes and ASSA ABLOY Entrance Systems recommendations for power-operated pedestrian doors. Service and adjustments performed by your ASSA ABLOY Entrance Systems-authorized representative, will ensure safe and proper operation of your automatic door unit.

Electronic equipment reception interference

The equipment may generate and use radio frequency energy and if not installed and used properly, it may cause interference to radio, television reception or other radio frequency type systems.

If other equipment does not fully comply with immunity requirements, interference may occur.

There is no guarantee that interference will not occur in a particular installation. If this equipment does cause interference to radio or television reception, which can be determined by turning the equipment off and on, the user is encouraged to try to correct the interference by one or more of the following measures:

- Re-orient the receiving antenna.
- Relocate the receiver with respect to the equipment.
- Move the receiver away from the equipment.
- Plug the receiver into a different outlet so that equipment and receiver are on different branch circuits.
- Check that protective earth (PE) is connected.

If necessary, the user should consult the dealer or an experienced electronics technician for additional suggestions.

Environmental requirements

ASSA ABLOY Entrance Systems products are equipped with electronics and may also be equipped with batteries containing materials which are hazardous to the environment. Disconnect power before removing electronics and battery and make sure it is disposed of properly according to local regulations (how and where) as was done with the packaging material.

Product liability

According to regulations, the following are the responsibility of the owner or caretaker of the equipment

- that the equipment operates correctly, so that it gives sufficient protection in regard to safety and health
- that the equipment is operated and regularly maintained, inspected and serviced by someone with documented competence in the equipment and in applicable regulations
- that the provided "Service Log Book" and "Site Acceptance Test and Risk Assessment" documents (PRA-0003) are kept available for maintenance and service records
- that inspection covers the emergency opening function (when applicable)
- that the closing force is appropriate for the door size on fire-approved door systems (when applicable).

Warranty

ASSA ABLOY Entrance Systems warrants its products to be free from defects in material and workmanship under intended use and service for a warranty time of 12 months, beginning at time of delivery. This warranty extends only to the original buyer of the equipment.

ASSA ABLOY Entrance Systems warrants that the software will operate substantially in accordance with its functional descriptions and that it has been recorded on non-defective media.

The ASSA ABLOY Entrance Systems warranty does not apply to

- That the software will be error-free or operate without interruption
- General wear and tear on the system
- Fuse, disposable batteries and glass damage
- System deviations caused by installer other than ASSA ABLOY Entrance Systems
- System that has been altered or damaged by vandalism or misuse
- System that has been additionally equipped with non-ASSA ABLOY Entrance Systems original branded parts and/or spare parts
- Unrequired visits due to poor client communication (door working when our technician arrives, reset, power discontinuation)
- Adjustments (closing and opening speed and also detection field radars) due to customer requests (excludes operational adjustments thought to create a hazard)
- Water damage
- Adverse weather conditions
- Any damage caused, directly or indirectly, by a circumstance beyond the control of the applicable company within ASSA ABLOY Entrance Systems, such as industrial dispute, fire, natural disaster, war, extensive military mobilization, insurrection, requisition, seizure, embargo, restrictions in the use of power and defects or delays in deliveries by sub-contractors caused by any such circumstances

Please note:

- Non-compliance with manufacturers care and maintenance recommendations may void the warranty.
- ASSA ABLOY Entrance Systems-authorized resellers shall extend this warranty to end-users only, but have no authority to extend a greater or different warranty on behalf of ASSA ABLOY Entrance Systems.
- A service agreement with ASSA ABLOY Entrance Systems will help secure the availability of a fully operational system and will give priority at call-out, thus minimizing the time that the equipment is unusable.

Service

Inspections should be done regularly by a trained and qualified person. The frequency of these inspections should be according to national regulations (or according to industry standard if there are no national regulations). This is especially important when the installation concerns a fire-approved door or a door with an emergency-opening function. To extend the life of your investment and ensure safe and reliable operation of the door, we recommend a minimum of 2 visits per year or more, depending on usage and operating conditions. Environmental aspects shall also be considered.

As your entrances are part of your business flow, there's every reason to keep them working well. ASSA ABLOY Entrance Systems offers you a maintenance and modernization expertise to rely on. Our Maintenance Programs and Modernization Services for entrance automation is backed by a extensive expertise for all types of pedestrian- and industrial door and docking systems, independent of brand. At your disposal is a team of dedicated expert technicians, proven through decades of maintenance, service and satisfied customers.

Intended use

The door is designed to offer continuous use, a high degree of safety and maximum lifetime. The system is self-adjusting to the effects caused by normal variations in the weather conditions and to minor friction changes caused by e.g. dust and dirt.

This door is not intended for escape routes unless approved by local authority having jurisdiction.

The ASSA ABLOY UniTurn is an automatic revolving door developed to provide draught free access to buildings.

The door can be used indoors or outdoors. Outdoor use with water resistant cover.

For installation and maintenance see Installation and Service manual 1003087.

Technical specification

Manufacturer:	ASSA ABLOY Entrance Systems
Address:	Lodjursgatan 10, SE-261 44 Landskrona, Sweden
Type:	UniTurn
Mains power supply:	230V, 50/60Hz, mains fuse max. 10AT or 100-120V, 50/60Hz, mains fuse max. 16AT
Power consumption:	Drive unit 600W LED spot lights max. 70W LED panel lights max. 170W
Temperature range:	-20 to +50°C
Degree of protection:	IP20
Degree of protection, control actuators:	IP54
Sound pressure:	$L_{pa} \leq 70 \text{ dB}(A)$
Approvals:	Third party approvals from established certification organizations valid for safety in use, see Declaration of Conformity.

How the ASSA ABLOY UniTurn works

The UniTurn is designed to maintain a draught-free environment at the same time allowing high traffic-flow with or without trolleys and wheelchairs. The large size of the compartment allows wheelchairs, shopping and luggage trolleys to easily and safely pass through the revolving door.

The door is designed so that operation is not affected or interrupted by winds or by users pushing the doors. However, in emergency situations or when power failure occurs, the door runs by battery to the emergency position. The lock for the escape doors, centre double swing door panels are released and can be manually broken out and give a clear evacuation path through the centre.

The UniTurn design comes equipped with standard safety devices in both the horizontal and vertical plane.

Main parts

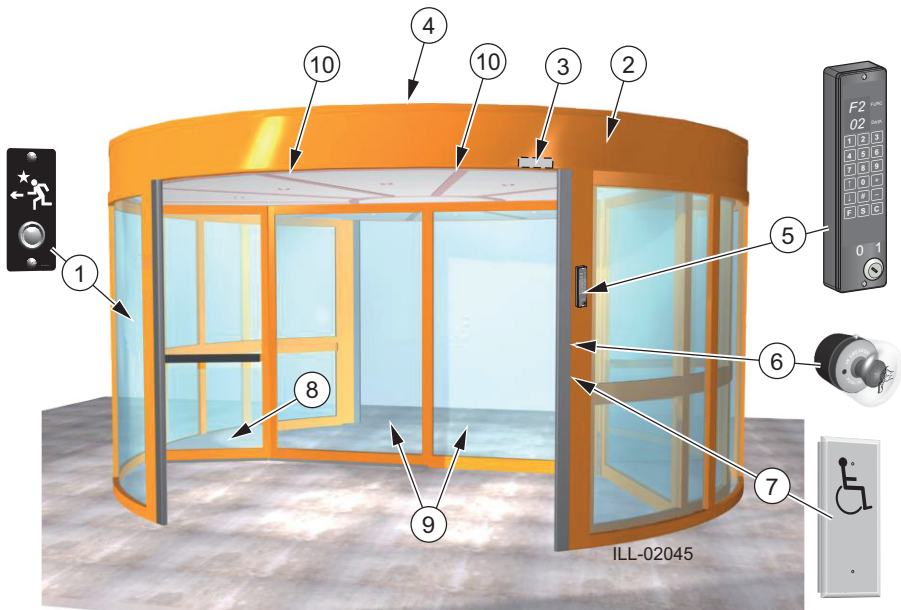

No.	Description
1	Push button inside, the door will rotate 360°
2	Main control unit CDC (behind fascia sheets)
3	Safety photocell (PDR)
4	Dust protection roof Standard: max load 0 kg, do not walk or store any material on the roof! With roof reinforcement option: max load 1500 kg (evenly distributed over the entire surface)
5	Program Control Device (PCD) with ON/OFF key switch (standard place)
6	Emergency stop button
7	Activation by disabled people: Recommended, if applicable (option)
8	Display area (max. load 25 kg/each)
9	Door leaves with escape function, where approved by local authority having jurisdiction
10	Activation units

Settings and operation PCD

The PCD (Program Control Device) is used to select what operating mode is active when the ON/OFF switch is in the ON position. It is also used to check and set door configuration.

General information PCD

Key	Function
0-9	Numeric inputs
#	Confirm access code input
↑	Setpoint selection upwards
↓	Setpoint selection downwards
+	Setpoint value change upwards
-	Setpoint value change downwards
F	Function selection
S	Setpoint confirmation and storage
C	Error clear (20, 30) Clear display Leave menu
 ILL-01914	ON/OFF switch 1 = ON 0 = OFF



Information prompts on PCD display

Prompt	Description
P1	ON/OFF switch in OFF position.
P2	Service request. Call ASSA ABLOY Entrance Systems for service.
P3	Real time operation ON, see " Real time operation " on page 14.
P4	Climate control ON

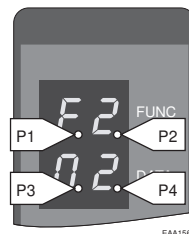

The door configuration must be set by ASSA ABLOY Entrance Systems Service technicians.

Access code

To be able to operate the PCD it is required to login with an access code.

Login on the PCD

- 1 Press # to clear the display.
- 2 Enter the access code 1234. The display shows ==.
- 3 Press # to confirm the input.

If the access code is correct the display shows

LI (Login)

0 1 (Level 01)

In case of four consecutive failed login attempts, five minutes must pass before a new attempt can be made.

Logout from the PCD

- 1 Press # to clear the display.
- 2 Enter the access code. The display shows ==.
- 3 Press # to confirm the input.
If the access code is correct the display shows
LO (Logout)
0 1 (Level 01)
- 4 Automatic logout ten minutes after the last key press.
- 5 Automatic logout can be inhibited by typing **F561** on the PCD.

Change access code

At delivery the access code is 1234. To change, follow the procedure below.

- 1 Type **#1234#**. If the access code is correct the display shows
LI (Login)
0 1 (Level 01)
- 2 Type **F41**. The display shows
F 4
L 1
- 3 Enter new code (4 digits).
- 4 Press **S** to confirm.
- 5 Enter the new access code a second time.
- 6 Press **S** to confirm.

The ON/OFF switch

The ON/OFF switch can be used in any of the operating modes 01-06 and 08-09 if automatic sliding doors are installed. In the ON (1) position, the door operates according to selected operating mode. Setting the switch to OFF (0) is indicated by prompt P1 on the display and is equivalent to selecting the operating mode Locked (OFF) 01 (see page 12).

Key impulse switch

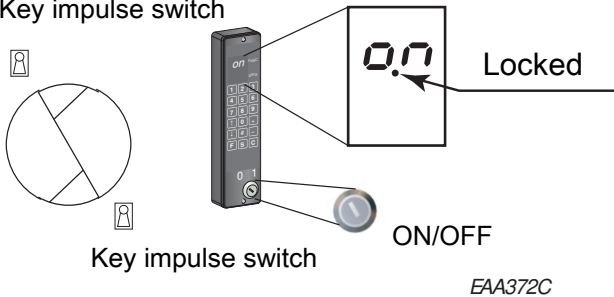

Key impulse switch (option)

If the door is locked with the ON/OFF switch it can be opened with a key switch (ask your local ASSA ABLOY Entrance Systems Service). When the key switch is activated, the door unlocks, runs 360° and locks again.

Changing operating mode

- 1 Login on the PCD.



- 2 Type F2. (The display shows F2 plus current operating mode.)
- 3 Use the up or down arrow to change the operating mode 01-09.
- 4 Confirm the change and exit the operating mode selection function by pressing S.

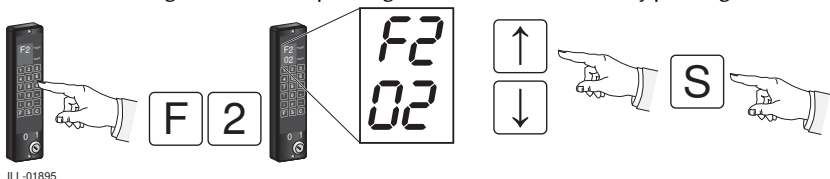

- 5 Logout from the PCD



The different operating modes

Locked (Off) 01

The door rotates to its closed position. If an electro-mechanical lock is fitted, the lock is activated. The door can be opened with the key impulse switch, see [Key impulse switch \(option\)](#) on page 11.

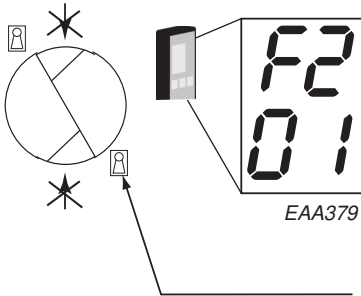

Automatic operation, start from open position 02

The door is parked in open position when there is no traffic. As soon as the outside or inside activation units detect approaching traffic, the door starts rotating.

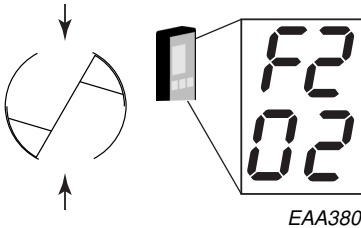

Automatic operation, start from closed position 03

The door is parked in closed position when there is no traffic. As soon as the outside or inside activation units detect approaching traffic, the door starts rotating.

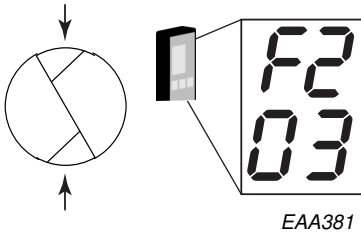

Automatic operation, start from open position exit only 04

The door is parked in open position when there is no traffic. As soon as the inside activation units detect approaching traffic, the door starts rotating.

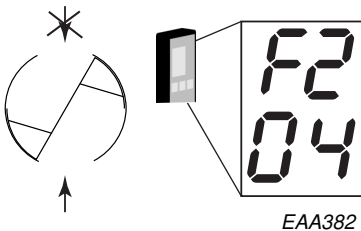

Automatic operation, start from closed position exit only 05

The door is parked in closed position when there is no traffic. As soon as the inside activation units detect approaching traffic, the door starts rotating.

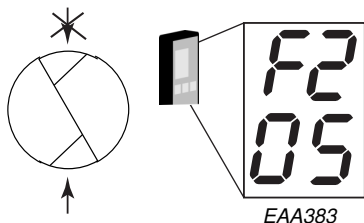

Continuous rotation 06

The door rotates at a low speed. As soon as the outside or inside activation units detect approaching traffic, the door accelerates to normal speed. The door returns to low speed when there is no traffic.

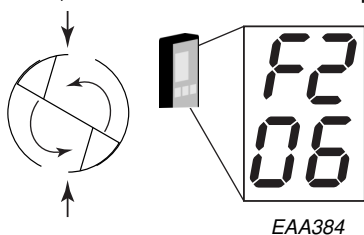

Manual operation "Cleaning position" 07

The door rotates forward as long as the key + is held down and backwards as long as the - key is held down.

Note: During manual operation, safety devices are disconnected.

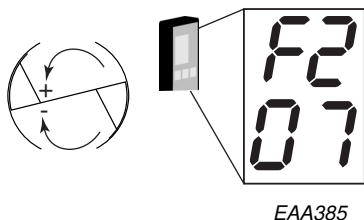

Summer position 08

The door is parked in the escape position and the escape doors are unlocked. Close the escape door before changing from summer position to automatic operation. If automatic service doors are installed, they will open automatically and remain open until another operating mode is selected or the ON/OFF switch is set to OFF.

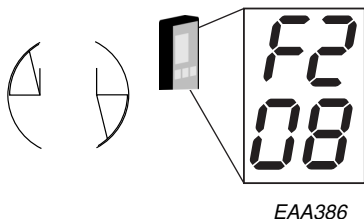

Automatic service doors 09

The door is parked in the escape position and the service doors are unlocked. As soon as the outside or inside activation units detect approaching traffic, the service doors opens.

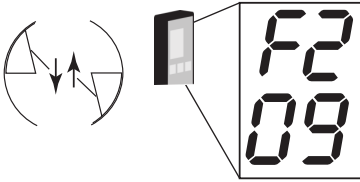

EAA387

Real time operation

Programming of real time operation must be done by ASSA ABLOY Entrance Systems service technicians. Fill in form on next page.

The CDC-system has three different day schedules. Each day schedule may contain up to 10 different operating modes. The week schedule informs the system of which day schedule to run and in what order during a week. It is possible to make up to 16 exceptions from this week schedule for e.g. public holidays etc.



Activation

Type **F556** (Real time operation ON).
Prompt P3 lights up.

The door operates according to schedule.

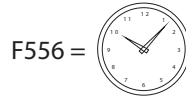

F556 =

Deactivation

Type **F557** (Real time operation OFF).
Prompt P3 extinguishes.

The door operates according to manually set operating mode.

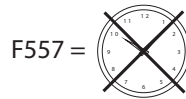

F557 =

ON/OFF switch

The OFF (0) position overrides real time operation. The door will be locked. When set to the ON (1) position, the door resumes operation according to schedule.



EAA204

Manual setting of operating mode

If the door is running in real time operation and the operating mode is manually changed, real time operation is automatically deactivated. To resume real time operation type **F556**.

Summertime/Wintertime

To change from summertime to wintertime, type **F53** and select option number 02 with arrow \downarrow/\uparrow keys. Press + or - to select setting 00 or 01, (summertime off (wintertime) is value 00 and summertime on is value 01) and press S (select). To check the time change, see [Real time clock](#).

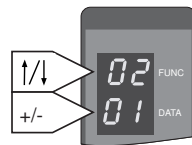

EAA400

Day schedule

Day schedule 1	Day schedule 2	Day schedule 3
1	1	1
2	2	2
3	3	3
4	4	4
5	5	5
6	6	6
7	7	7
8	8	8
9	9	9
10	10	10

Week schedule

Week day	Schedule
Monday	
Tuesday	
Wednesday	
Thursday	
Friday	
Saturday	
Sunday	

Exceptions

Start exception	End exception	Exception schedule
1	1	1
2	2	2
3	3	3
4	4	4
5	5	5
6	6	6
7	7	7
8	8	8
9	9	9
10	10	10
11	11	11
12	12	12
13	13	13
14	14	14
15	15	15
16	16	16

Read speed settings

Type **F3**. The display shows S1.
Use **↑** or **↓** to select setpoint number to read.
Press **C** to leave the menu.

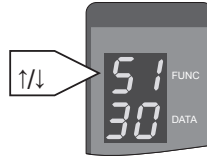

EAA254

Setpoint	Description	Setpoint value
S1	High speed setpoint	0.5-4.0 rpm
S2	Low (handicap) speed setpoint	0.1-2.5 rpm
S3	Creep speed setpoint	Fixed at 0.5 rpm
S4	Continuous speed setpoint	0.5-2.0 rpm
S5	Manual speed setpoint	0.1-2.0 rpm
S6	Reverse speed setpoint	0.1-2.0 rpm
S9	Door size parameter	1-9

Real time clock

The CDC system has a real time clock built in. The clock is used for event log recording and when the door is running according to a real time operation schedule.

Read real time clock

Type **F71**. The display shows 11 and the parameter value corresponding to year.

Use **↑** or **↓** to select parameter number and display the parameter value.

Press **C** to leave the menu.

Summer and wintertime, see [Summertime/Wintertime](#) on page 14.

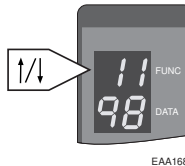

EAA168

11	Year
12	Month
13	Day
14	Hour
15	Minute
16	Second

Safety

The safety systems are monitored to ensure the high safety level of the door.

The condition of the safety equipment is periodically tested. This monitoring is made during normal running conditions and it does not affect the normal day-to-day operations of the door.

Every 24 hours (normally at the first start up) the brakes and motors are tested. The test takes about one minute and is carried out as follows:

- 1 The door runs close to the closed position and stops.
- 2 The brakes are activated.
- 3 The door tries to run with the brakes on and checks for any movement.

Safety devices on the door



- Slow field
- Stop field

Touchless presence detection sensors placed in ceiling

Slow field, slows down the speed to 0.5 rpm.

When the slow field is activated the display shows **S25**.

Stop field, stops the door.

When the stop field is activated the display shows **S26**.

The sensors are monitored by the system twice every revolution. Depending on where the door is located the two detection fields can be configured to stop or to slow down the speed. Picture shows default setting.

The pressure sensitive safety edges

When a safety edge is compressed, the door stops with active brakes and the display shows **S10**.

Note! When the escape doors are not in locked position the display also shows **S10**.

The photocells PDR

The photocells, one inside and one outside, are in operation approx. 25° from the drum edge. They are in operation until the trailing edge of the rotating part has past the drum edge.

When the inside photocell is activated the display shows **S21** and when outside is activated it shows **S22**. As soon as the safety devices are deactivated the door starts and runs normally again.

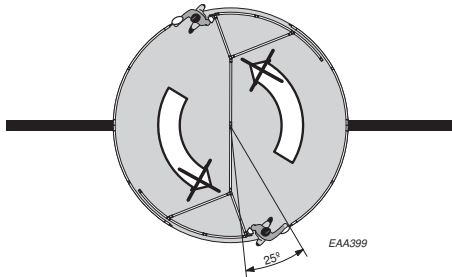

Note! If any of those displayed messages **S21**, **S22**, **S25**, **S26**, and **S10** are shown without any obvious cause, see Code list on page [Section Code list on page 25](#)).

Push buttons inside door

They will make the door rotate 360°.

These can be used if someone gets trapped in the door.



Even if the door is without mains power the push button wakes up the battery and gives an impulse.

Battery

Runs the door to emergency position in case of power failure.

Emergency operation

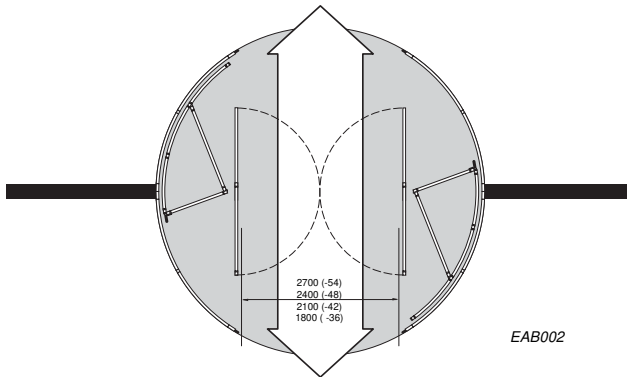

When power failure occurs, the door runs by battery to the emergency position. The lock for the escape doors, centre double swing door panels are released and can be manually broken out and give a clear evacuation path through the centre. The escape doors have to be manually closed after use. When closed, and mains is restored or the fire alarm system no longer indicates an emergency, the door will resume normal operation.

Fire alarm

If the door is connected to the building's fire alarm system, it will run to the emergency position and the escape door leaves will release when the fire alarm is activated. The display shows **S31**.

If the escape doors have not been opened, the door goes back to normal operation as soon as the fire alarm is deactivated.

If the escape doors have been opened, perform the start up procedure, [Section Start up after power failure, fire alarm or other status codes on page 20](#).



Start up after power failure, fire alarm or other status codes

If the escape doors have been opened, the display shows **S10**.
To release the emergency lock and close the door leaves:

- 1 Press emergency stop button.
The display shows **E20** and the lock is released.
- 2 Turn back the emergency stop button.
- 3 Close the door leaves correctly and press **C** on the PCD.



Regular safety checks

To help you fulfil the national/international requirements and to avoid malfunction and risk for injuries, we have provided the following checklist.



Do not use the door if repair or adjustment is necessary.

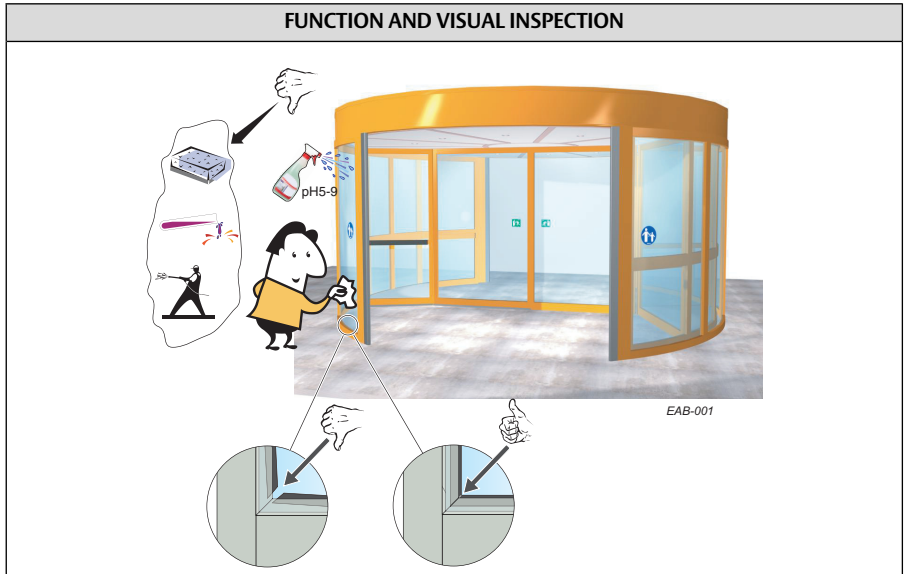

Daily Action		If problem occurs
Inspect your door and check <i>visually</i> for <ul style="list-style-type: none"> • condition of door seals and weather stripping ① • condition of glazing rubbers ② ③ 		☞
Check the safety sensors if any. If you are unsure of which type of sensor you have, please contact your ASSA ABLOY Entrance Systems representative.		☞
Press Emergency opening button and fold the door leaves. Test that all door leaves can be released and are not mechanically jammed. Press Emergency stop button and fold the door leaves.		☞
Escape doors	Note! If the door is placed in an escape route, tests must be performed regularly by trained personnel or fire department, according to local laws.	☞

☞ = Contact your ASSA ABLOY Entrance Systems service representative. For contact information, see last page.

CLEANING

The best way to remove dust and dirt from the ASSA ABLOY UniTurn and to maintain the quality of the enamel layer, the surfaces should be cleaned three times/year (once/four months period) with gentle (pH 5-9), non-polishing detergent and water. Use a soft non-abrasive sponge. The cleaning should be documented. To avoid damages to the profiles the brushes must be vacuum-cleaned weekly.

- Do not expose windows, doors or profiles to alkalis. Both aluminium and glass are sensitive to alkalis.
- Do not clean with high-pressure water. Operator, programme selector and sensor may be damaged and water may enter the profiles.
- Do not use detergents or abrasive additives.
- Do not scrub with materials like Scotch-brite, as this will cause mechanical damage.

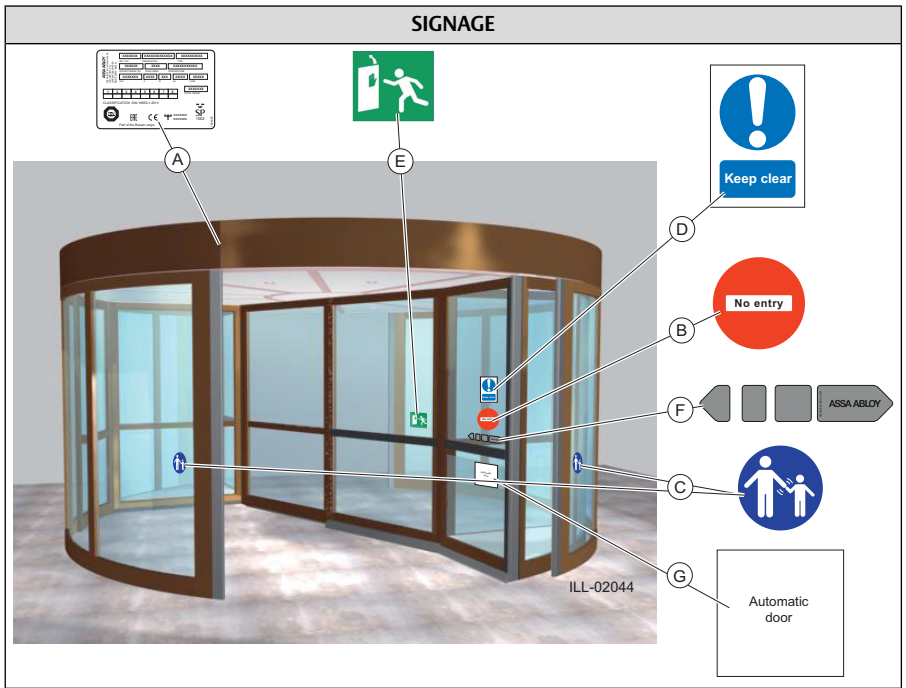

Daily Action		If problem occurs
Check that all required signage is applied and intact. Mandatory indicates that the signage is required by European directives and equivalent national legislation outside the European Union.		
(A)	Product label: Mandatory	
(B)	No entry, identifying one-way traffic: Mandatory in GB and US, if applicable, not included in the product.	
(C)	Supervision of child (applied to both sides of the door): Mandatory according to national regulations. Recommended, if the risk analysis shows use by children.	
(D)	Keep clear	
(E)	Emergency break-out: Mandatory, if approved for escape route.	
(F)	ASSA ABLOY Entrance Systems door sticker: Mandatory, if applicable to highlight the presence of the glass (applied to all glass sections that are moving).	
(G)	Automatic door	

= Contact your ASSA ABLOY Entrance Systems service representative. For contact information, see last page.

Troubleshooting

What's wrong?	Remedies
The motor does not start up	Make sure that the PCD display shows ON, and that mains power to the door is on.
	Check the operating mode, see The ON/OFF switch on page 11.
	Check that there are no objects in the safety detection zone.
	See Section Start up after power failure, fire alarm or other status codes on page 20 for start up procedure.
The motor starts but door will not rotate	Check that nothing is jammed beneath the door.
The door does not close	Change the setting of the program selector, see page 9 .
	Check that there are no objects in the safety detection zone.
	Check that nothing is jammed beneath the door.
If the problem continues, please contact your ASSA ABLOY representative.	

Supervision system

The ASSA ABLOY UniTurn has a built-in supervision system.

During normal operation the display will show ON. If an error occurs, the PCD display will show a status code. All status codes are shown with permanent figures. The exceptions are code 20 and 30, which will be shown flashing.

To reset the door to normal operation after a status code, type C on the PCD, [Section Code list on page 25](#).

Code list

Code	Status	Cause	Remedy
ON	The revolving door is functioning normally		
10	Stop		Check for obstacles between the wing and the floor and between the wing and the inside of the drum. Check safety edges. Close escape doors.
11	Electromechanical lock error	No signal from the electromechanical lock	Make one more unlock/lock operation. If that does not help call ASSA ABLOY Entrance Systems Service.
12	Mechanical lock locked		Unlock the mechanical lock.
20	Emergency stop	Emergency stop button depressed	Release the button by turning it in the direction of the arrows, then restore function by pressing C on the PCD.
21	Response from the PDR sensor fitted above the opening on the inside	Inner PDR sensor activated	Remove obstacle in the inner detection zone
22	Response from the PDR sensor fitted above the opening on the outside	Outer PDR sensor activated	Remove obstacle in the outer detection zone.
25	Response from the touchless door leaf sensors (the door rotates slowly)	The detection zone of the touchless door leaf sensor activated	Remove obstacle in the detection zone.
26	Response from the touchless door leaf-sensors (the door stops)	The detection zones of the touchless door leaf sensors activated	Remove obstacle in the detection zone.
30	Blocked door	The wing is blocked by an obstacle	Check for obstacles between the wing and the floor and between the wing and the inside of the drum. After checking press C.
31	Fire alarm	The fire alarm system has, if connected, been activated	Check the fire alarm system.
32	Power fail input	Main power lost	Check main fuse. Check external power supply.
36	Battery error	Battery pack not charged. Emergency drive battery faulty	Allow the battery pack to recharge (30 min.).

Note! In most cases the door can be locked with the electromechanical lock even if the door does not function. Push the door to the closed position, and lock the door with the ON/OFF key switch. The door has only one closed position, if the door does not lock, turn 180°.



= For all other status codes, contact your ASSA ABLOY service representative.
For contact information, see last page.

Service/Maintenance

Service and adjustments performed by your ASSA ABLOY Entrance Systems-authorized representative will ensure safe and proper operation of your automatic door unit.

Remember to keep “Service Log Book” and “Site Acceptance Test and Risk Assessment” documents (PRA-0003) available. These are used together.

The table below shows the recommended interval in revolutions, when to replace parts during preventive maintenance. Talk to your ASSA ABLOY Entrance Systems representative to learn more about our service offering.

Minimum maintenance interval of once a year. See EN16005.

Part	Revolutions	Action
Motor	300.000/1.500.000	Check/Replace
Brakes	200.000/3.000.000	Check/Replace
Safety device	300.000	Check
Impulse device	300.000	Check
Gear box	3.000.000	Check
Drive belt	300.000/600.000	Check/Replace
Motor carbon brushes	300.000/600.000	Check/Replace
Escape door locks	300.000/3.000.000	Check/Replace

Service request

After 200.000 revolutions the prompt P2 indicates that it is time for service.

Minimum maintenance interval of once a year. See EN 16005.

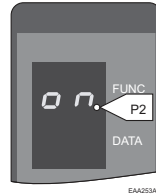

Remote Control Operation

To operate the door and perform service checks, the CDC system can be connected to a computer via the RS 232 connection COM port. It can be connected directly or via a modem. Ask your local ASSA ABLOY Entrance Systems distributor for more information.



Software communication

Windows 3.1 or higher is required to communicate with the door system. Make following settings.

- 1 Windows 3.1/3.11.
Start terminal under Accessories.
or
- 2 Windows 95/98 and Windows XP.
Start HyperTerminal under Accessories.
- 3 Windows 7, 8 and Vista does not include terminal software. A free alternative, *PuTTY*, can be downloaded from www.putty.org
- 4 Make the following settings.
 - VT100
 - 8 bits data
 - No parity
 - One stop bit
 - 9600 baud
 - No flow control

Communication ON/OFF

Communication via the COM port can be switched ON (default) or OFF from the PCD.

External communication ON: Type **F552** on the PCD.

External communication OFF: Type **F553** on the PCD.

Login

To enable login on the MDT, the PCD must be logged out.

Press **ESC** to display the login prompt.

CDC Login:

Enter Access Code:

Type the access code 1234 (displayed as ****) and confirm with the **Enter** key.

If the display shows: !!!! the PCD is logged in.

If the access code was entered successfully the current login level is displayed briefly.

Login level = 1

Whereupon the CDC main menu appears.

Logout

Automatic logout occurs ten minutes after the last key press. The automatic logout can be inhibited by entering PCD command F561.

To log out manually, select Logout from the main menu by pressing number key **6**.

Logout Menu

Current Access Level = 1

Logout ? (Y/N)

Press **Y** to logout or **N** to return to the main menu.

Main menu

CDC Main Menu

Door Type UniTurn

Software Release : Ver 4.11.00 P1 #A388 2004-09-29

Press key to select function: _

1 : Door Operation

2 : Configuration

3 : Diagnostic Functions

4 : Log Functions

5 : Development Functions

6 : Logout

Press the NUMBER KEY 1 to get to the door operation page.

Press **ESC** to go to this menu from any submenu.

Door operation

CDC Door Operation Page

Error/Status Display: ON
Operating Mode: 2
Door Speed (RPM/10): 30
Door Position (deg): 114
Revolution Counter: 14
Date & Time: Wednesday 2013-12-11 16:35:08

Operating modes:

1 : Lock Door
2 : AUTO Open= Start from open position
3 : AUTO Closed = Start from closed position
4 : EXIT Open = Start from open position, inner impulse only
5 : EXIT Closed = Start from closed position, inner impulse only
6 : Continuous Rotation
7 : Manual Operation
8 : Summer Position
9 : Automatic Service Doors

Press function key: C : Error Clear
I : Inner Key Impulse
O : Outer Key Impulse
R : Real Time Operation ON/OFF
A : Air Condition/Climate Control ON/OFF

Select operating mode by pressing corresponding number key.

Press **Enter** to confirm changes.

Press **ESC** to return to main menu.

Other information on screen

Manually locked

The ON/OFF switch is in OFF position. Inner and outer key impulses from terminal are disabled.

Service request

The door has been running for 200.000 revolutions.

Call for service.

Real time

Real time operation is active.

Press **R** to toggle real time operation ON/OFF.

Climate control

Climate control is active.

Press **A** to toggle climate control ON/OFF.

Real time + Climate control

Real time and Climate control operations are active.

External Operating Mode

External Operating Mode is active.

Options

Even though the UniTurn is installed to comply with all applicable safety regulations, it is possible to enhance safety/comfort with the following add-ons (please contact your local ASSA ABLOY Entrance Systems company for detailed description).

Emergency stop button on the outside

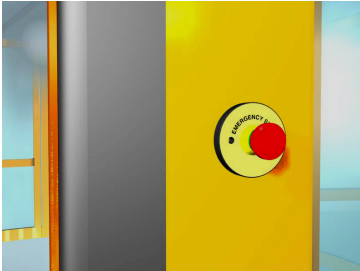

In case of an emergency, door rotation can be stopped by pressing the Emergency stop button. To reset the door to normal rotation after the emergency situation has ceased, [Section Start up after power failure, fire alarm or other status codes on page 20](#). The functionality of the emergency stop buttons shall be tested once a year.

Lock system

Electromechanical lock (option)

Doors in escape route can not be equipped with electromechanical lock.

When the door is in locked position the motorized 25mm lock bolt engages with a 10mm striker plate on the rotating part. If there are any problems with this lock the display shows **E11**. Make an unlock or a lock command when **E11** appears. If it does not disappear, call ASSA ABLOY Entrance Systems Service.

Mechanical lock (option)

Mechanical lock is used to lock the door when the door has lost power or due to status codes the door can not run to locked position. The display shows **S12** when the mechanical lock is activated. If the lock is used as an extra lock, the door must run to its locked position by operating mode 01 or the ON/OFF key switch set to OFF, before the mechanical lock key is turned.

Note! If the display does not show **S12** (ON remain), service shall be requested to avoid damage to the door.

Automatic sliding centre door leaves



The automatic sliding doors can, in addition to the PCD, also be operated by a separate key switch, that overrides operating mode 02-06 and 08-09 selected with the PCD.

The switch has 3 positions:



Normal rotation (automatic sliding doors off)



Automatic sliding doors activated



OPEN

When the switch is set to “automatic sliding doors” position, the revolving door rotates to its emergency position and stops.

The sliding doors opens when the outside or inside activation units detect approaching traffic.

When the switch is set back to “normal rotation”, the door will start to rotate as soon as the sliding doors are closed.

When the switch is set to OPEN, the revolving door rotates to its emergency position and stops. The sliding doors will then open, and stay open as long as the switch stays in this position.

Fire alarm

In case of a fire the door can be used for smoke evacuation. If connected to the fire alarm system, the revolving door rotates to its emergency position and stops. The sliding doors will then open, and stay open as long as the fire alarm is activated.

Reception panel

The reception panel contains a Program Control Device (PCD), a key impulse and an emergency stop button. The key impulse makes the door rotate 360°. The maximum distance from the door to the reception panel is 100 m.



Extra PCD

It is possible to have two PCDs connected to the CDC, example one on the door and one maximum 100 m from the door.

Climate control



Activation

Type **F554** (Climate control ON).

Prompt P4 lights up.

When the temperature is below the temperature set on the thermostat the climate control changes the following operating modes:

AUTO OPEN to AUTO closed

EXIT OPEN to EXIT closed

Continuous rotation to AUTO closed (operating mode

AUTO closed will remain)

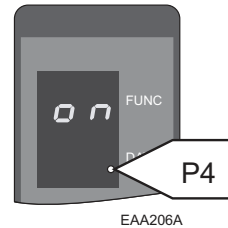

If the temperature remains below the thermostat setting, the climate output is activated after 10 minutes to start the air curtain.

Operating mode "Locked door" (01) or ON/OFF switch in OFF position automatically deactivates the climate output (air curtain OFF).

Operating modes Manual (07), Summer position (08) and Automatic Service door (09) do not deactivate the climate control output (air curtain remains ON if climate control input is active).

Deactivation

Type **F555** (Climate control OFF).

Prompt P4 extinguishes.

The door operates according to operating mode set by real time operation or manually.

Quick guide changing operating mode

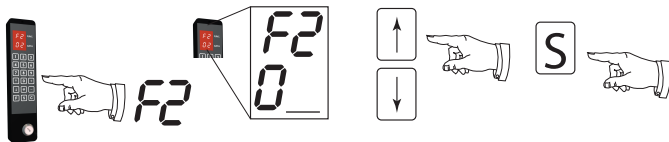

	<p>F556 = </p> <p>F557 = </p> <p>ON </p>	<p>F554 = </p> <p>F555 = </p> <p>ON </p>

--	--	--

Other products from ASSA ABLOY Entrance Systems

- Door Systems
- Balance doors
- Air curtains
- Sliding doors
- Swing doors
- Automatic and manual activation units
- Overhead sectional doors
- Service such as preventive maintenance and upgrade programs, emergency repairs, service advice and door management
- Vertical lifting fabric doors
- Dock levelers
- Dock shelters
- Folding doors
- High speed doors
- Loadhouses

Declaration of conformity

ASSA ABLOY
Entrance Systems

Experience a safer
and more open world

We **ASSA ABLOY Entrance Systems AB**
Lodjurgatan 10
SE-261 44 Landskrona
Sweden

declare under our sole responsibility that the type of equipment:

UniTurn

complies with the following directives:

2014/30/EU ElectroMagnetic Compatibility Directive (EMCD)

2006/42/EC Machinery Directive (MD)

2011/65/EU on the restriction of the use of certain hazardous substances in electrical and electronic equipment with the applicable amendments (RoHS)

Harmonized European standards which have been applied:

EN ISO 13849-1:2015

EN 60335-1: 2012+A13:2017

EN 60335-2-103:2015

EN 61000-6-2:2005

EN 61000-6-3:2007+A1:2011

EN 16005:2012

Other standards or technical specifications, which have been applied:

IEC 60335-1 ed. 5:2010

IEC 60335-2-103 ed. 2:2006+A1:2010

Certificate issued by a notified or competent body (for full address, please contact ASSA ABLOY Entrance Systems AB) concerning the equipment:

BY/112 02.01. 020 08532

The manufacturing process ensures the compliance of the equipment with the technical file. The manufacturing process is regularly assessed by 3rd party.

The CE mark was first applied 2006-04-01.

Compilation of technical file:

Anders Forslind

ASSA ABLOY Entrance Systems AB

Lodjurgatan 10

SE-261 44 Landskrona

Sweden

Place
Landskrona

Date
2020-10-08

Signature
Klas Hagelin

Position
Global Quality Manager



DoC 1001682-en-16.0

ASSA ABLOY Entrance Systems is a leading supplier of entrance automation solutions for efficient flow of goods and people. Building on the long-term success of the Besam, Crawford, Albany and Megadoor brands, we offer our solutions under the ASSA ABLOY brand. Our products and services are dedicated to satisfying end-user needs for safe, secure, convenient and sustainable operations. ASSA ABLOY Entrance Systems is a division within ASSA ABLOY.

assaabloyentrance.com



ASSA ABLOY Entrance Systems

Tel: +46 10 47 47 000
info.aes@assaabloy.com
assaabloyentrance.com